



FABBRICA BANDIERE · FLAG MANUFACTURER

“Adzia Bandiere,”



CATALOGO GENERALE

2022

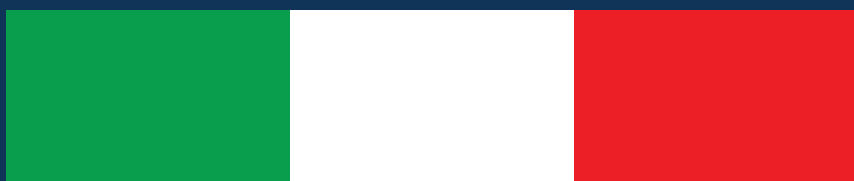

ATLANTE DELLE BANDI



FABBRICA BANDIERE
"Adria Bandiere"
FLAG MANUFACTURER
 Via Arno, 23 47042 Cesenatico - FC - Italy
 Tel. 0039 0547 672090 - Fax 0547 672048
 Internet: www.adriabandiere.com
 E-mail: info@adriabandiere.com

INTERNATIONAL

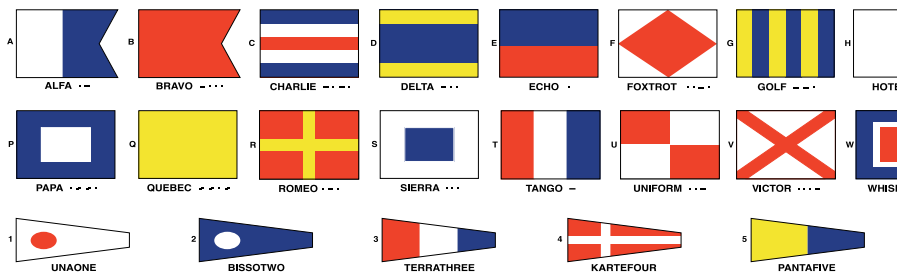

ERE - THE FLAGCHART



AL CODE FLAGS

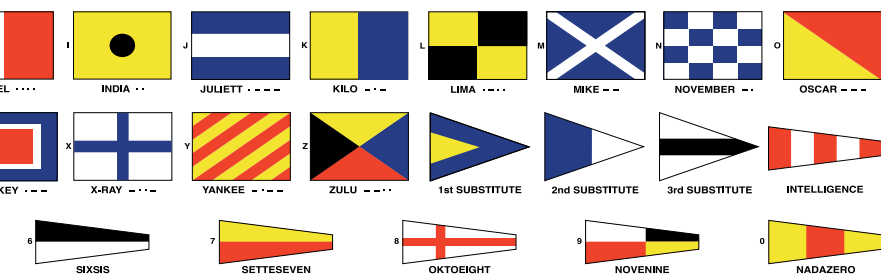

- BANDIERE NAZIONALI ED ESTERE
- BANDIERE PUBBLICITARIE
- BANDIERE RICAMATE
- GRAN PAVESE
- LABARI E GONFALONI
- GAGLIARDETTI
- FASCE DA SINDACO
- BANDIERINE DA TAVOLO
- PENNONI, ASTE ED ACCESSORI

- NATIONAL AND FOREIGN FLAGS
- ADVERTISING FLAGS
- EMBROIDERED FLAGS
- INTERNATIONAL CODE FLAGS
- LABARUMS AND BANNERS
- PENNANTS
- MAJOR'S SASHES
- SMALL TABLE FLAGS
- FLAGSTAFFS, POLES AND ACC.

Produzione di bandiere nazionali, estere e personalizzate, gagliardetti, labari, striscioni, articoli pubblicitari e accessori per bandiere.

Production of national, international and customized flags, pennants, labarums, banners, advertising items and flags accessories.



ELENCO NAZIONI - NATIONS' LIST

Nell'elenco di seguito riportato indichiamo il gruppo di riferimento per il prezzo di ogni nazione, i settori 6 delle nazioni indicati con asterisco (6*) per tutte le misure e con apice (6^) dall misura 130x200 indicano riferimenti per prezzi netti. --- In the following list we specify the price group for each nationality, and all 6 group nations with asterisk (6*) for all sizes and with apicce (^) from size cm. 130x200, show net price.

| | | | | |
|-----------------------------------|-----------------------------------|----------------------------|--------------------------------|---|
| 4 Afghanistan | 6* Christmas Island | 4 Honduras | 5 Netherlands Antilles | 4 Slovakia |
| 5 Aland Island | 6 Cocos Islands | 3 Hong Kong | 1 New Caledonia (Francia) | 4 Slovenia |
| 3 Albania | 1 Colombia | 1 Hungary | 6* New Caledonia local flag | 6 Solomon Islands |
| 1 Albania Civil Ensign | 4 Colombia Civil Ensign | 3 Iceland | 6 New Zealand | 3 Somalia |
| 4 Albania Naval Ensign | 6* Commonwealth | 4 India | 6* Newis local flag | 6* Somaliland |
| 6* Alderney | 6* Commonwealth Indipt. State | 1 Indonesia | 6 Nicaragua | 6 South Africa |
| 4 Algeria | 6 Comoros | 6 Iran | 4 Niger | 6* South Georgia & South Sandwich Island |
| 6* American Samoa | 3 Congo - Brazaville | 4 Iraq | 1 Nigeria | 5 South Korea |
| 6 American Virgin Islands | 5 Congo Kinshasa (RDC) | 1 Ireland | 6* Niue | 6* South Sudan |
| 6 Andorra | 6 Coni | 6* Islamic Conference | 4 Norfolk | 2 Sovereign Military Order of Malta |
| 6 Angola | 5 Cook Islands | 6 Isle of Man | 4 Norfolk Island | 6 Spain |
| 6 Anguilla | 2 Corsica | 6 Isle of Man Civil Ensign | 6 North Korea | 1 Spain Civil ensign |
| 6* Antartica | 1 Costa Rica | 4 Israel | 6 North Macedonia | 6^ Sri Lanka |
| 6^ Antigua & Barbuda | 6 Costa Rica state flag | 1 Italy | 6* Northern Cyprus | 6* St. Barths |
| 6* Arab League | 4 Croatia | 1 Ivory Coast | 6* Northern Ireland | 6 St. Maarten |
| 4 Argentina | 5 Cuba | 4 Jamaica | 6* Northern Marianas | 6* St. Helena & Dependencies |
| 1 Argentina Civil Ensign | 6 Curacao | 2 Japan | 3 Norway | 6 St. Kitts & Nevis |
| 1 Argentina Naval Ensign | 3 Cyprus | 6* Japan Naval Ensign | 6 Norway state flag | 6 St. Lucia |
| 1 Armenia | 3 Czech Republic | 6 Jersey | 6* OAS | 6* St. Pierre & Miquelon |
| 5 Aruba | 2 Denmark | 5 Jordan | 6* OAU | 6 St. Vincent & the Grenadines |
| 6* Asean | 5 Denmark Naval Ensign | 6* Jordan Naval Ensign | 5 Olympic Games | 4 Sudan |
| 5 Australia | 4 Djibouti | 6* Jordan Royal Flag | 4 Oman | 4 Suriname |
| 5 Australia Civil Ensign | 6^ Dominica | 6^ Kara Kalpak | 6 OPEC | 6* Swaziland |
| 5 Australia Naval Ensign | 6 Dominican Republic | 6^ Kazakhstan | 6* Pacific Community | 2 Sweden |
| 1 Austria | 6* East Timor | 6 Kenya | 4 Pakistan | 4 Switzerland |
| 4 Azerbaijan | 6 Ecuador | 6^ Kiribati | 4 Palau | 4 Syria |
| 6* Azores | 1 Ecuador National Civil Ens. | 4 Kuwait | 4 Palestine | 4 Taiwan |
| 4 Bahamas | 4 Egypt | 6 Kyrgyzstan | 4 Panama | 5 Tajikistan |
| 6 Bahamas Civil Ensign | 6* Egypt Naval Ensign | 4 Laos | 6^ Papua New Guinea | 5 Tanzania |
| 4 Bahrain | 6 El Salvador | 1 Latvia | 6* Papua New Guinea Naval Ens. | 3 Thailand |
| 3 Bangladesh | 5 Elba Isle | 4 Lebanon | 6 Paraguay | 6* Tibet |
| 4 Bangladesh Civil Ensign | 2 England | 6 Lesotho | 6 Perù | 4 Togo |
| 4 Barbados | 6 Equatorial Guinea | 6 Liberia | 4 Philippines | 6 Tokelau (Nuova Zelanda) |
| 6 Barbados Naval Ensign | 6 Eritrea | 5 Libya | 6* Pitcairn Islands | 3 Tonga |
| 5 Belarus | 1 Estonia | 4 Liechtenstein | 1 Poland | 6 Turks & Caicos Islands |
| 1 Belgium | 5 Ethiopia | 1 Lithuania | 6* Poland Civil ensign | 6^ Tuvalu |
| 6* Belgium Naval Ensign | 2 European Union | 1 Luxembourg | 6 Portugal | 6 Uganda |
| 6 Belize | 6 Falkland Island | 6* Luxembourg Civil Ensign | 4 Puerto Rico | 1 Ukraine |
| 3 Benin | 3 Faroes Island | 6* Macao | 4 Qatar | 4 Unesco |
| 6 Bermuda | 6 Fiji | 1 Madagascar | 4 Quebec | 4 Unicef |
| 6 Bermuda Governm. Ensign | 2 Finland | 4 Madeira | 3 Red Crescent | 3 United Arab Emirates |
| 6 Bhutan | 1 France | 6 Malawi | 3 Red Cross | 2 United Kingdom |
| 1 Bolivia | 1 French Guiana (Francia) | 6 Malaysia | 1 Repubblica Srpaka | 5 United Kingdom Naval Ensi. |
| 6* Bolivia Naval Ensign | 6 French Polynesia | 5 Maldives | 6* Réunion | 4 United Kingdom Red ensign |
| 6 Bonaire | 6* French South. & Antartic Lands | 1 Mali | 1 Romania | 2 United Nations (ONU) |
| 6^ Bosnia & Herzegovina | 1 Gabon | 5 Malta | 4 Russian Fed. Naval ensign | 2 United States |
| 4 Botswana | 4 Gambia | 6 Malta Civil Ensign | 1 Russian Federation | 5 Uruguay |
| 5 Brazil | 4 Georgia | 6 Marshall Islands | 6 Rwanda | 6 Uzbekistan |
| 6* British Antartic Territory | 1 Germany | 6 Martinique | 6 Saba | 6 Vanuatu |
| 6* British Indian Ocean Territ. | 3 Ghana | 4 Mauritania | 6* Sami | 6 Vatican City |
| 6 British Virgin Island | 5 Gibraltar | 3 Mauritius | 5 Samoa | 4 Venezuela |
| 6 British Virg. Island Civil Ens. | 6* Gibraltar Civil Ensign | 1 Mayotte (Francia) | 6 San Marino | 3 Viet Nam |
| 6^ Brunei | 2 Greece | 6 Mexico | 5 Sao Tomè & Principe | 6* Wake Island |
| 1 Bulgaria | 4 Greenland | 4 Micronesia | 3 Sardinia | 6* Wales |
| 3 Burkina Faso | 6^ Grenada | 6 Moldova | 6* Sark | 6 Wallis & Futuna |
| 5 Burundi | 1 Guadalupe (France) | 1 Monaco | 5 Saudi Arabia | 5 Western Sahara |
| 6 Cambodia | 6* Guadalupe | 6 Mongolia | 6* Saudi Arabia Civil ensign | 1 Yemen |
| 3 Cameroun | 6 Guam | 6^ Montenegro | 6* Saudi Arabia Naval ensign | 6 Zambia |
| 2 Canada | 6 Guatemala | 6 Montserrat | 3 Scotland | 6 Zimbabwe |
| 6 Cape Verde | 6 Guernsey | 4 Morocco | 6 Scotland Royal | |
| 6* Caricom | 6* Guernsey Civil Ensign | 6 Mozambique | 6* Seborga | |
| 6 Caymand Island | 1 Guinea | 4 Myanmar | 3 Senegal | |
| 6 Caymand Island Civil Ensign | 4 Guinea-Bissau | 6 Namibia | 6 Serbia | |
| 6 Central African Republic | 6 Guyana | 4 Nato | 6^ Seychelles | |
| 1 Chad | 1 Haiti | 6 Nauru | 6 Sicily | |
| 3 Chile | 6 Haiti State Flag | 6^ Nepal | 1 Sierra Leone | |
| 3 China | 5 Heard & McDonald Island | 1 Netherlands | 4 Singapore | |

About Us...

La storia di Adria Bandiere nasce nel 1973 quando la creatività e la passione del Cavalier Domenico De Ascentiis, supportate dalle doti organizzative della moglie Antonella, hanno dato vita a questo progetto cresciuto e sviluppato nel corso degli anni con grandi soddisfazioni.

Nata dapprima al servizio del settore turistico nazionale e ampliata successivamente a quello nautico internazionale, fino a quello sportivo, pubblicitario e promozionale, l'azienda oggi vanta una sviluppata e consolidata rete commerciale conosciuta in tutto il mondo.

Ogni singolo articolo viene creato unendo l'esperienza artigiana, il costante sviluppo tecnologico e il continuo investimento economico, che consente la realizzazione di una gamma di prodotti altamente customizzati, originali e di elevata qualità.

Il prodotto, costantemente monitorato da un processo produttivo che assicura l'applicazione delle norme UNI EN ISO 9001:2015, dal 2000 rispetta standard produttivi molto alti e conta sulla manifattura abile, accurata e sapiente di ogni dipendente che, in tanti anni di lavoro, oggi rappresenta una ricchezza importante nella sfida del nuovo sistema economico.

The history of Adria Bandiere starts in 1973 when the creativity and passion of Domenico De Ascentiis, supported by organized skills of the wife Antonella, have allowed him to realize this project developed during years with great satisfactions.

Created firstly for the national touristic sector and then expanded to international nautical sector, up to sport, promotional and advertising one, today the company boasts a well-developed and consolidated commercial network known throughout the world.

Each item is created by combining the consolidated artisan experience, constant technological development and continuous economic investment, allowing the creation of a range of highly customized, original and high quality products.

The product, constantly monitored by a production process that ensures the application of the UNI EN ISO 9001:2015, since 2000 respects high production standards and relies on skillful, accurate and wise manufacture of each employee who, in many years of work, today represents an important asset in the challenge of this new economic system.

EVERYDAY LIFE





Indice - Index

| | |
|---|----|
| Art.24B Bandiere Nazioni Orizzontali - Horizontal National Flags | 8 |
| Art.26B Bandiere Nazioni Verticali - Vertical National Flags | 9 |
| Art.13B Bandiera Italia Marina Mercantile - Italian Civil Ensign Flag | 10 |
| Art.08B Bandiera Italia Marina Militare - Italian Navy Flag | 10 |
| Art.06B Bompresso - Bowsprit Flag | 11 |
| Art.07B Fiamma Marina Militare - Navy Pennant | 11 |
| Art.70B Manica a Vento - Windsock | 11 |
| Art.14B11 Guidone VV.FF. - Italian Military Pennant | 12 |
| Art.108B Guidone GDF - Italian Military Pennant | 12 |
| Art.09B Guidone CC - Italian Military Pennant | 12 |
| Art.14B Guidone Italia Postale - Italian Post Pennant | 12 |
| Art.54B Guidone della Polizia di Mare - Coast Guard Police Pennant | 12 |
| Art.65B Bandiere Regioni Italiane - Italian Regional Flags | 13 |
| Art.AU Bandiere Australia - Australian Flags | 14 |
| Art.24B Bandiere Isole dei Caraibi - Caribbean Islands Flags | 14 |
| Art.96B Bandiera Danimarca - Danish Flag | 15 |
| Art.81B Bandiera Finlandia - Finnish Flag | 15 |
| Art.99B Bandiere Regionali Francesi - French Regional Flag | 15 |
| Art.95B Bandiere Regionali Germania e Austria- German and Austrian Regional Flag | 16 |
| Art.97B Bandiere Gran Bretagna - Great Britain Flags | 17 |
| Art.97B Bandiere Regionali Gran Bretagna - Great Britain Regional Flags | 17 |
| Art.80B Bandiere Norvegia - Norwegian Flag and Pennant | 18 |
| Art.98B Bandiere Regionali Olandesi - Dutch Regional Flags | 18 |
| Art.85B Bandiere Regionali Spagnole - Spanish Regional Flags | 19 |
| Art.16B Gran Pavese - International Code Flags Set | 20 |
| Art.18B Contenitore Gran Pavese - International Code Flags Set Bag | 20 |
| Art.17B Bandiera Lettera "A" Segnasub - Diving Letter "A" Signal Flag | 21 |
| Art.19B Bandiera Segnasub - Diver Down Flag | 21 |
| Art.23B Confezione Con Blister - Blister Packaging | 21 |
| Art.BLISTBO Scatola Gran Pavese - Storage Box for I.C. Set | 21 |
| Art.51B Bandiere Comunità Europea Con Inserto - EEC Community Flags | 22 |
| Art.45B01 Tabella del Codice Internazionale - International Code Board | 22 |
| Art.45B02 Tavola con Rosa Dei Venti - Compass Card Table | 22 |
| Art.99B Pochette "N", "C", "Francia" - Flags Letter "N", "C" and France with clutch bag | 22 |
| Art.15B Guidone di Venezia (San Marco) - Venetian (San Marco) Pennant | 23 |
| Art.27B Bandiere di Fantasia - Fun Flags | 23 |
| Art.23B Guidoni Sociali - Customized Pennants | 24 |
| Art.46B Adesivi - Stickers | 24 |
| Art.22B Bandiere Personalizzate - Customized Flags | 25 |
| Art.22BV/Art.22BG - Beach Flags e accessori - Beach flags and accessories | 28 |
| Art.25BRU Roll Up | 33 |
| Art.25B Stendardo - Banner | 34 |

| | |
|--|----|
| Art.25BA Kit Espositivo con bandiera -Exhibition Kit with Flag | 36 |
| Art.64B03 Bandiere Personalizzate da interno - Customized indoor Flags | 37 |
| Art.03B Set per Interno - Indoor Set Flag | 38 |
| Art.61B Gonfaloni -Banners | 40 |
| Art.44B Accessori per Gonfalone - Banner accessories | 41 |
| Art.02B Fascia da Sindaco - Mayor Sash | 42 |
| Art.05B02 Fiocco a Lutto - Mourning Ribbon | 43 |
| Art.05B01 Fiocco Tricolore - Italian Ribbon | 43 |
| Art.05B03 Nastro Azzurro Ricamato - Blue Ribbon | 43 |
| Art.54B Coccarda - Cockade | 44 |
| Art.30B01 Bandierine da Tavolo - Small Table Flags | 45 |
| Art.29B Gagliardetti - Social Pennants | 47 |
| Art.21B01 Sciarpe Personalizzate - Customized Scarfs | 48 |
| Art.21BF Foulard | 48 |
| Art.31B Bandierine da Sventolare - Hand Waving Flags | 49 |
| Art.20B Festoni - Festoons | 51 |
| Art.44B30 Borsa Personalizzata- Customized Bag | 54 |
| Art.21B Pochette e Zaini Personalizzati - Customized Pochette and Backpack | 54 |
| Art.44B30 Borsa e Zaino Shopper- Shopper Bag and Backpack | 55 |
| Art.21BCU Copri Cuscino Personalizzato- Customized Pillow Cover | 55 |
| Art.01A17D Bandiera con attacchi palo per la luce- Flag with attachment for light pole | 56 |
| Art.31B04/31B05 Bandiere Personalizzate da Parete - Customized Wall Flags | 56 |
| Art.43B Basette da Tavolo - Table Stands | 57 |
| Art.43B Bandierine per Auto - Car Flags | 57 |
| Art.37B Aste per Interno - Indoor Flag Pole | 58 |
| Art.39B Basi per Interno - Indoor Base | 59 |
| Art.42B Puntali per Aste - Flag Pole Ferrules | 60 |
| Art.79B Traversino per Gonfalone - Banner Crossbar | 60 |
| Art.49B Asta in Velluto - Velvet Pole | 60 |
| Art.35B Aste per esterno - Outdoor Poles | 61 |
| Art.40B Attacchi Murali per Esterno - Outdoor Wall Attachments | 62 |
| Art.38B Basi per Esterno - Outdoor Bases | 63 |
| Art.38B08 Piantana Sottoruota - Underwheel Base | 63 |
| Art.01A01/01A02/01A03/01A04 Accessori Asta - Pole Accessories | 63 |
| Art.34T Pennone Telescopico - Telescopic Mast | 64 |
| Art.38T Base per Pennone - Mast Base | 64 |
| Art.34B Pennone in Alluminio - Aluminium Mast | 65 |
| Art.34C Pennone in Alluminio con Braccio Rotante - Aluminium Rotating Arm Mast | 66 |
| Art.34FI Pennone in Alluminio con Fune Interna - Aluminium Mast with Internal Halyard | 67 |
| Art.34FI WIND TRACK Pennone in Alluminio con Wind Track - Aluminium Mast with Wind Track | 68 |
| Art.34VFE Pennone in Vetrosesina - Fiberglass Mast | 69 |
| Art.34VBR Pennone in Vetrosesina con Braccio Rotante - Fiberglass Mast with Rotating Arm | 70 |
| Art.34VFI Pennone in Vetrosesina con Fune Interna - Fiberglass Mast with Internal Halyard | 71 |
| Art.34VFI WIND TRACK Pennone in Vetrosesina con Wind Track - Fiberglass Mast with Wind Track | 72 |
| Art.Accessori per Pennone - Mast Accessories | 73 |

Art. 24B Bandiere di Nazioni Orizzontali - Horizontal Nations Flags

Bandiere di nazioni, formato orizzontale, realizzate in tessuto stammina di poliestere 100%, confezionate con doppio orlo perimetrale, guaina di rinforzo e sagola per affissione all'asta. Misure indicate nella tabella sottostante.

*National flags, horizontal shape, made of 100% woven polyester, with double hem, sheath and rope.
Sizes available in the table below.*



Misure (cm x cm) · Sizes (cm x cm)

| | | | | | | | | | |
|-------|-------|-------|-------|--------|--------|---------|---------|---------|---------|
| 20x30 | 30x45 | 40x60 | 50x75 | 70x100 | 80x120 | 100x150 | 130x200 | 150x225 | 200x300 |
|-------|-------|-------|-------|--------|--------|---------|---------|---------|---------|

Art. 26B Bandiere di Nazioni Verticali - Vertical Nations Flags

Bandiere di nazioni, formato verticale, realizzate in tessuto stammina di poliestere 100%, confezionate con doppio orlo perimetrale, guaina di rinforzo lato asta, moschettoni in PVC oppure asola in alto chiusa a battente per braccio rotante, con occhielli a vela lato asta. Misure indicate nella tabella sottostante.

National flags, vertical shape, made of 100% woven polyester, with double hem, sheath, PVC snap hooks or with hole at the top for rotating arm. Sizes available the table below.



Misure (cm x cm) · Sizes (cm x cm)

210x70

300x100

Art. 13B Italia Marina Mercantile - Italian Civil Ensign Flag

Bandiera Italia Marina Mercantile realizzata in tessuto stammina di poliestere 100%, confezionata con doppio orlo perimetrale, guaina di rinforzo e sagola per affissione all'asta. Grandezze disponibili indicate nella tabella sottostante.

Italian Civil Ensign made of 100% woven polyester with double hem, sheath and rope. Sizes available in the table below.

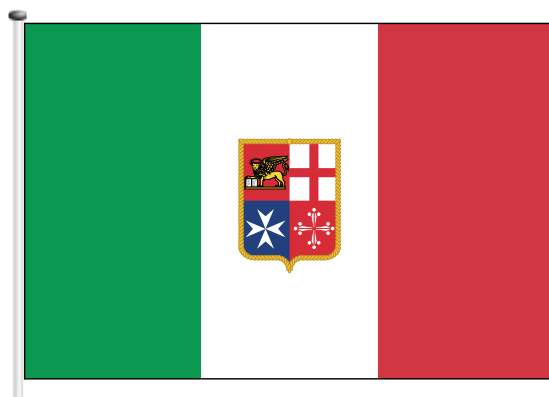

| Tessuto · Textile | | |
|---|-------|-------|
| Poliestere economico . Economic polyester | | |
| Misure (cm x cm) · Sizes (cm x cm) | | |
| 20x30 | 30x45 | 40x60 |

| Tessuto · Textile | | | | | | | | | | |
|---|-------|-------|-------|-------|--------|--------|---------|---------|---------|---------|
| Stamina di poliestere 100% . 100% Woven Polyester | | | | | | | | | | |
| Misure (cm x cm) · Sizes (cm x cm) | | | | | | | | | | |
| 20x30 | 30x45 | 40x60 | 50x75 | 60x90 | 70x100 | 80x120 | 100x150 | 130x200 | 150x225 | 200x300 |

Art. 08B Italia Marina Militare - Italian Navy Flag

Bandiera Italia Marina Militare realizzata in tessuto stammina di poliestere 100%, confezionata con doppio orlo perimetrale, guaina di rinforzo e sagola per affissione all'asta. Grandezze disponibili nella tabella sottostante.

Italian Navy Flag made of 100% woven polyester with double hem, sheath and rope. Sizes available in the table below.



| Misure · Sizes | 1° grand/size | 2° grand/size | 3° grand/size | 4° grand/size | 5° grand/size | 6° grand/size | 7° grand/size | 8° grand/size |
|-------------------------------|---------------|---------------|---------------|---------------|---------------|---------------|---------------|---------------|
| Inferitura / Casting for pole | 550 cm | 400 cm | 250 cm | 150 cm | 100 cm | 80 cm | 45 cm | 30 cm |
| Lunghezza / Lenght | 825 cm | 600 cm | 375 cm | 225 cm | 150 cm | 120 cm | 70 cm | 45 cm |

Art. 06B Bompreso - Bowsprit Flag

Bandiera di Bompreso realizzata in tessuto stamina di poliestere 100%, confezionata con doppio orlo perimetrale, guaina di rinforzo e sagola per affissione all'asta. Grandezze disponibili nella tabella sottostante.

Bowsprit flag made of 100% woven polyester with double hem, sheath and rope. Sizes available in the table below.



| Misure · Sizes | 3 ^a grand/size | 4 ^a grand/size | 5 ^a grand/size | 6 ^a grand/size | 7 ^a grand/size |
|-------------------------------|---------------------------|---------------------------|---------------------------|---------------------------|---------------------------|
| Inferitura / Casting for pole | 250 cm | 150 cm | 100 cm | 80 cm | 40 cm |
| Lunghezza / Length | 250 cm | 150 cm | 100 cm | 80 cm | 40 cm |

Art. 07B Fiamma Marina Militare - Navy Pennant

Fiamma della Marina Militare realizzata in tessuto stamina di poliestere 100% e confezionata con doppio orlo perimetrale, guaina di rinforzo e sagola per affissione all'asta. Grandezze disponibili nella tabella sottostante.

Navy Pennant made of 100% woven polyester with double hem, sheath and rope. Sizes available in the table below.



| Misure · Sizes | 1 ^o grand/size | 2 ^o grand/size | 3 ^o grand/size | 4 ^o grand/size | 5 ^o grand/size | 6 ^o grand/size | 7 ^o grand/size | 8 ^o grand/size |
|-------------------------------|---------------------------|---------------------------|---------------------------|---------------------------|---------------------------|---------------------------|---------------------------|---------------------------|
| Inferitura / Casting for pole | 15 cm | 15 cm | 12 cm | 12 cm | 8 cm | 8 cm | 8 cm | 8 cm |
| Lunghezza / Length | 2000 cm | 1500 cm | 1000 cm | 500 cm | 230 cm | 200 cm | 86 cm | 70 cm |

Art. 70B Manica a Vento - Wind Sock

Manica a vento per eliporto e ereoporto disponibile in diverse misure, realizzata in tessuto stamina di poliestere 100% cucita a bande bianche e rosse, o personalizzata, completa di ferro di sostegno alla circonferenza, funi e redancia.

Wind sock available in different sizes, made of polyester with sewn white and red stripes, or custom, complete of support iron for circumference, ropes and thimble.



Misure (ø x cm x ø) · Sizes (ø x cm x ø)

| | | | |
|-----------------|-----------------|-----------------|-----------------|
| ø30 x 140 x ø20 | ø50 x 140 x ø25 | ø50 x 250 x ø25 | ø80 x 540 x ø25 |
|-----------------|-----------------|-----------------|-----------------|

Art. 14B11 Guidone VVFF - Italian Military Pennant

Guidone insegna distintivo del Naviglio dei Vigili del Fuoco di mare, realizzato in tessuto stammina di poliestere 100%, stampato a colori passanti, confezionato con doppio orlo perimetrale, guaina di rinforzo e sagola per affissione all'asta. Disponibile in diverse grandezze.

Pennant made of 100% woven polyester, printed with pass-through silk-screen printing, with double hem, sheath and rope.

Art. 10B Guidone GdF - Italian Military Pennant

Guidone insegna distintiva del Naviglio della Guardia di Finanza, realizzato in tessuto stammina di poliestere 100%, stampato a colori passanti, confezionato con doppio orlo perimetrale, guaina di rinforzo e sagola per affissione all'asta.

Pennant made of 100% woven polyester, printed with pass-through silk-screen printing, with double hem, sheath and rope.

Art. 09B Guidone CC - Italian Military Pennant

Guidone insegna distintivo del Naviglio dei Carabinieri realizzato in tessuto stammina di poliestere 100%, stampato a colori passanti, confezionato con doppio orlo perimetrale, guaina di rinforzo e sagola per affissione all'asta.

Pennant made of 100% woven polyester, printed with pass-through silk-screen printing, with double hem, sheath and rope.

Art. 14B Guidone Italia Postale - Italian Post Pennant

Guidone Italia Postale realizzato in tessuto stammina di poliestere 100%, stampato a colori passanti, confezionato con doppio orlo perimetrale, guaina di rinforzo e sagola per affissione all'asta.

Pennant made of 100% woven polyester, printed with pass-through silk-screen printing, with double hem, sheath and rope.

Art. 54B Guidone della polizia di Mare - Coast Guard Police Pennant

Guidone insegna distintivo del Naviglio della Polizia di Mare realizzato in stammina di poliestere 100%, stampato a colori passanti, confezionato con doppio orlo perimetrale, guaina di rinforzo e sagola per affissione all'asta

Pennant made of 100% woven polyester, printed with pass-through silk-screen printing, with double hem, sheath and rope.

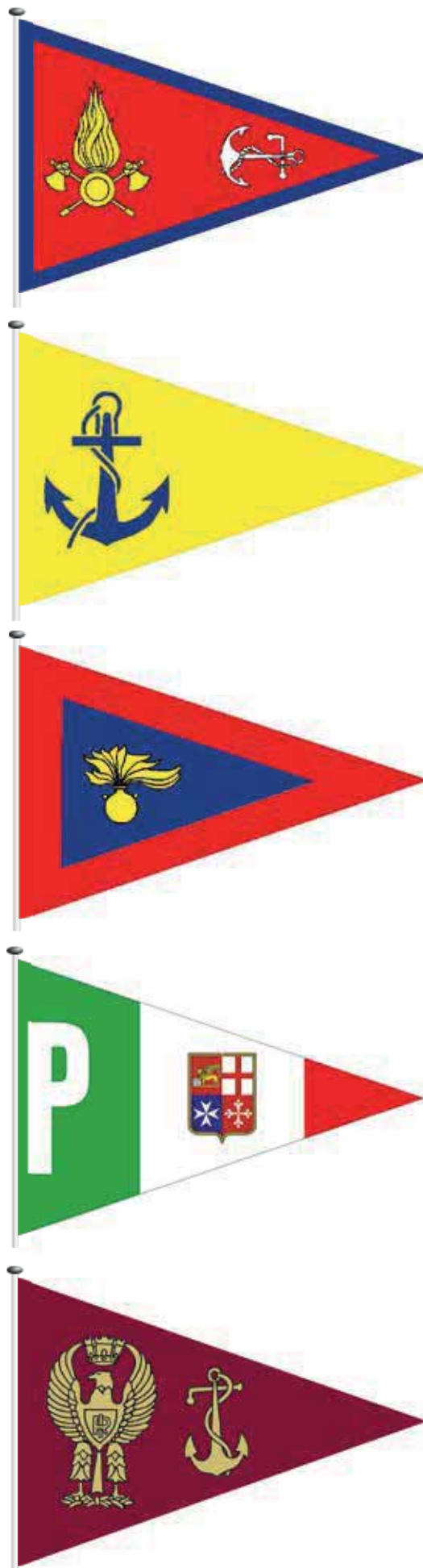

Art. 65B Bandiere Regionali Italiane - Italian Regional Flags

Bandiere delle regioni italiane, realizzate in tessuto stammina di poliestere 100% o poliestere nautico, confezionate con doppio orlo perimetrale, guaina di rinforzo e sagola per affissione all'asta. Misure e settori di riferimento nella tabella sottostante.

Italian regional flags, made of 100% woven polyester or knitted polyester, with double hem, sheath and rope. Sizes and reference sector in the table below.



| Regione | Sett. | Regione | Sett. | Regione | Sett. | Regione | Sett. |
|----------------|-------|-----------------------|-------|----------|-------|---------------------|-------|
| Abruzzo | 2 | Friuli Venezia Giulia | 6 | Molise* | 6 | Toscana | 3 |
| Basilicata | 2 | Lazio* | 6 | Piemonte | 6 | Trentino Alto Adige | 6 |
| Calabria | 3 | Liguria* | 6 | Puglia | 6 | Umbria* | 6 |
| Campania | 2 | Lombardia | 2 | Sardegna | 3 | Valle d'Aosta | 1 |
| Emilia Romagna | 3 | Marche | 5 | Sicilia | 6 | Veneto* | 6 |

Misure (cm x cm) · Sizes (cm x cm)

| | | | | | | | | | |
|-------|-------|-------|-------|--------|--------|---------|---------|---------|---------|
| 20x30 | 30x45 | 40x60 | 50x75 | 70x100 | 80x120 | 100x150 | 130x200 | 150x225 | 200x300 |
|-------|-------|-------|-------|--------|--------|---------|---------|---------|---------|

Art. AU - Bandiere Australia - Australian Flags

Bandiera Australiana, Nazionale o Mercantile o Militare, realizzata in tessuto stammina di poliestere 100%, confezionata con doppio orlo perimetrale, guaina di rinforzo e sagola per affissione all'asta, interamente stampata oppure con inserto Gran Bretagna cucito e stelle stampate o applicate. Misure indicate nella tabella sottostante.

Australian flags made of 100% woven polyester with double hem, sheath and rope entirely printed or with sewn Great Britain and stars applied. Sizes available in the table below.

| Australia | | Australia Naval Ensign | | Australia Civil Ensign | |
|--|---|--|-------|------------------------|--------|
|  |  |  | | | |
| Misure (cm x cm) · Sizes (cm x cm) | | | | | |
| | | | 30x60 | | 60x120 |

Art. 24B Bandiere Isole dei caraibi - Caribbean Islands Flags

Bandiere delle Isole Caraibiche realizzate in tessuto stammina di poliestere 100%, confezionate con doppio orlo perimetrale, guaina di rinforzo e sagola per affissione all'asta. Misure disponibili nella tabella sottostante.

Flags made of 100% woven polyester with double hem, sheath and rope. Sizes available in the table below.

| | | | | | | | | | |
|--|---|---|--|---|---|---------|---------|---------|---------|
|  |  |  |  |  |  | | | | |
|  |  |  |  |  |  | | | | |
|  |  |  |  |  |  | | | | |
|  |  |  |  |  |  | | | | |
|  |  |  |  |  |  | | | | |
|  | | | | | | | | | |
| Misure (cm x cm) · Sizes (cm x cm) | | | | | | | | | |
| 20x30 | 30x45 | 40x60 | 50x75 | 70x100 | 80x120 | 100x150 | 130x200 | 150x225 | 200x300 |

Art. 96B Bandiera Danimarca - Danish Flag

Bandiera Danese realizzata in tessuto stammina di poliestere 100%, cucita o stampata con forma rettangolare, confezionata con doppio orlo perimetrale, guaina di rinforzo e sagola per affissione all'asta. Misure disponibili nella tabella sottostante.

Danish flag made of 100% woven polyester, sewn or printed with rectangular shape, with double hem, sheath and rope. Sizes available in the table below.

Denmark



| Misure (cm x cm) · Sizes (cm x cm) | | | | | | | | | |
|------------------------------------|-------|-------|-------|--------|--------|---------|---------|---------|---------|
| 20x30 | 30x45 | 40x60 | 50x75 | 70x100 | 80x120 | 100x150 | 130x200 | 150x225 | 200x300 |

Art. 81B Bandiere Finlandia - Finnish Flags

Bandiere Finlandesi, nazionali e regionali, realizzate in tessuto stammina di poliestere 100%, confezionate con doppio orlo perimetrale, guaina di rinforzo e sagola per affissione all'asta. Misure disponibili nella tabella sottostante.

Finnish flags made of 100% woven polyester with double hem, sheath and rope, both printed or sewn. Sizes available in the table below.

Finland



Aland Island



| Tessuto . Textile | Misure (cm x cm) . Sizes (cm x cm) | | | | | | |
|---|------------------------------------|-------|-------|-------|-------|--------|---------|
| Bandiere stampate . Stammina di poliestere 100% Printed flags . 100% woven polyester | 18x30 | 25x40 | 31x50 | 46x75 | 55x90 | 74x120 | 100x163 |
| Bandiere cucite . Stammina di poliestere 100% Sewn flags . 100% woven polyester | | | 31x50 | 46x75 | 55x90 | 74x120 | 100x163 |

Art. 99B Bandiere Regionali Francesi - French Regional Flags

Bandiere delle regioni Francesi realizzate in tessuto stammina di poliestere 100%, confezionate con doppio orlo perimetrale, guaina di rinforzo e sagola per affissione all'asta. Misure disponibili nella tabella sottostante.

French regional flags made of 100% woven polyester with double hem, sheath and rope. Sizes in the table below.

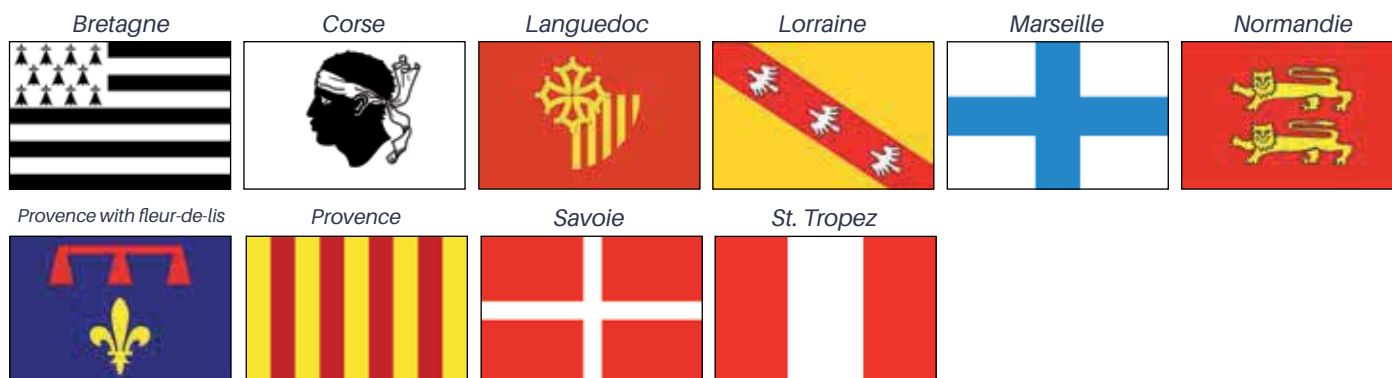

| Misure (cm x cm) · Sizes (cm x cm) | | | | | | | | | |
|------------------------------------|-------|-------|-------|--------|--------|---------|---------|---------|---------|
| 20x30 | 30x45 | 40x60 | 50x75 | 70x100 | 80x120 | 100x150 | 130x200 | 150x225 | 200x300 |

Art. 95B Bandiere Regionali Germania - German Regional Flags

Bandiere delle regioni della Germania realizzate in tessuto stammina di poliester 100%, confezionate con doppio orlo perimetrale, guaina di rinforzo e sagola per affissione all'asta. Misure disponibili nella tabella sottostante.

German regional flags made of 100% woven polyester with double hem, sheath and rope. Sizes in the table below.

| | | | | | |
|--|---|---|--|---|---|
| <i>Baden-Württemberg</i> | <i>Baden-Wür. emblem</i> | <i>Bayern emblem</i> | <i>Bayern</i> | <i>Berlin</i> | <i>Brandenburg</i> |
|  |  |  |  |  |  |
| <i>Bremen emblem</i> | <i>Bremen</i> | <i>Düsseldorf</i> | <i>Hamburg</i> | <i>Helgoland</i> | <i>Hessen</i> |
|  |  |  |  |  |  |
| <i>Kiel</i> | <i>Köln</i> | <i>Lübeck</i> | <i>Meck. Vorpommern</i> | <i>Meck. Emblem</i> | <i>Mecklemburg</i> |
|  |  |  |  |  |  |
| <i>Niedersachsen</i> | <i>Nord Friesland</i> | <i>Nordrhein-Westfalen</i> | <i>Pommern</i> | <i>Rheinland-Pfalz</i> | <i>Saarland</i> |
|  |  |  |  |  |  |
| <i>Freistaat Sachsen</i> | <i>Sachsen - Anhalt</i> | <i>Schleswig-Holstein emblem</i> | <i>Schleswig-Holstein</i> | <i>Sylt</i> | <i>Freistaat Thüringen</i> |
|  |  |  |  |  |  |
| <i>Baden</i> | | | | | |
|  | | | | | |

| Sizes (cm x cm) | | | |
|-----------------|-------|-------|-------|
| 20x30 | 30x45 | 40x60 | 50x75 |

Art. 95B Bandiere Regionali Austria - Austrian Regional Flags

Bandiere delle regioni dell'Austria realizzate in tessuto stammina di poliester 100%, confezionate con doppio orlo perimetrale, guaina di rinforzo e sagola per affissione all'asta. Misure disponibili nella tabella sottostante.

Austrian regional flags made of 100% woven polyester with double hem, sheath and rope. Sizes in the table below.

| | | | | | | |
|--|---|---|--|---|---|-------|
| <i>Burgenland</i> | <i>Karnten</i> | <i>Niederösterreich</i> | | | | |
|  |  |  | | | | |
| | | | Sizes (cm x cm) | | | |
| | | | 20x30 | 30x45 | 40x60 | 50x75 |
| <i>Salzburg</i> | <i>Steiermark</i> | <i>Tyrol</i> | <i>Oberösterreich</i> | <i>Wien</i> | <i>Vorarlberg</i> | |
|  |  |  |  |  |  | |

Art. 97B Bandiere Gran Bretagna - Great Britain Flags

Bandiere della Gran Bretagna (Red Ensign, Union Jack, Blue Ensign) cucite e/o stampate, realizzate in tessuto stammina di poliestere 100%, confezionate con doppio orlo perimetrale, guaina di rinforzo e sagola per affissione all'asta. Misure indicate nella tabella sottostante.

Flags made of 100% woven polyester (Red Ensign, Union Jack, Blue Ensign), sewn or printed in 100% woven polyester (Red Ensign, Union Jack), with double hem, sheath and rope. Sizes available in the table below.



| Tessuto . Textile | Misure Yard/Cm . Size Yard/Cm | | | | | | |
|--|-------------------------------|------------|-------------|-------------|-------------|------------|------------|
| Bandiere cucite in stammina 100% Red Ensign, Union Jack, Blue Ensign Sewn on woven polyester | 3/4 yard | 1 yard | 1+1/4 yard | 1+1/2 yard | 2 yard | 2+1/2 yard | 3 yard |
| | 40x68,5 cm | 46x91,5 cm | 58x114,5 cm | 68,5x137 cm | 92x183 cm | 116x228 cm | 137x274 cm |
| Bandiere stampate in stammina 100% Red Ensign, Union Jack Printed on woven polyester | 1/2 yard | 3/4 yard | 1 yard | 1+1/4 yard | 1+1/2 yard | | |
| | 30x45,7 cm | 40x68,5 cm | 46x91,5 cm | 58x114,5 cm | 68,5x137 cm | | |

Art. 97B Bandiere Regionali Gran Bretagna - Regional Great Britain Flags

Bandiere della Gran Bretagna cucite e/o stampate, realizzate in tessuto stammina di poliestere 100%, confezionate con doppio orlo perimetrale, guaina di rinforzo e sagola per affissione all'asta. Misure indicate nella tabella sottostante.

Regional Great Britain flags sewn or printed in 100% woven polyester, with double hem, sheath and rope. Sizes available in the table below.

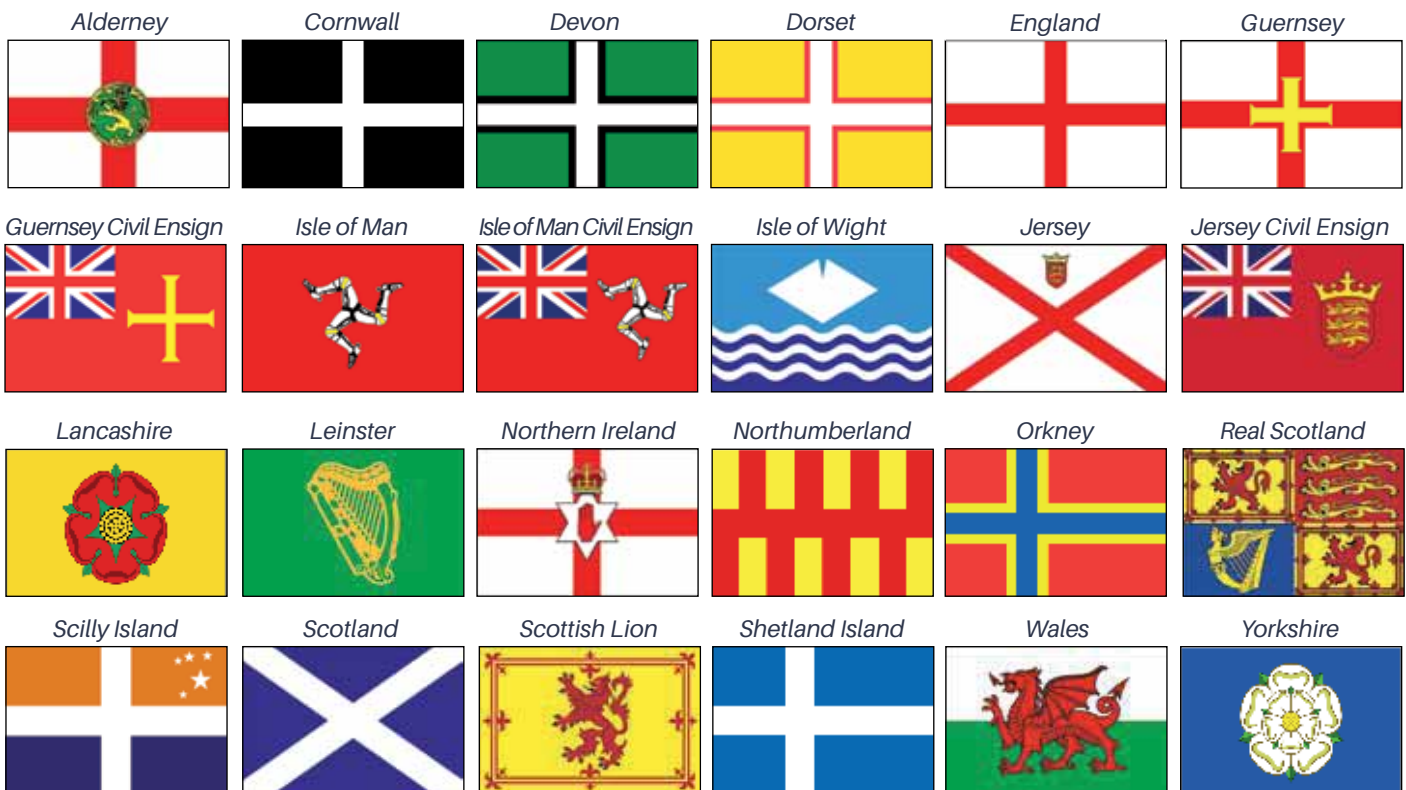

| Misure (cm x cm) · Sizes (cm x cm) | |
|------------------------------------|-------|
| 20x30 | 30x45 |

Art. 80B Bandiere Norvegia - Norwegian flag and pennant

Bandiera e fiamma norvegese realizzate in tessuto stammina di poliestere 100%, confezionate con doppio orlo perimetrale, guaina di rinforzo e sagola per affissione all'asta. Misure disponibili nella tabella sottostante.

Norwegian Flag and pennant made of 100% woven polyester with double hem, sheath and rope.

Sizes available in the table below.

Norway



Norway Pennant

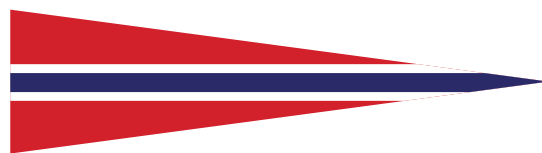

Bandiera Norvegese cucita . Sewn Norwegian Flag - Misure (cm x cm) · Sizes (cm x cm)

| | | | | | | | | | |
|---------|---------|---------|---------|---------|---------|---------|---------|---------|---------|
| 50x37 | 65x46 | 75x54 | 85x64 | 100x72 | 125x91 | 150x110 | 175x128 | 200x144 | 225x164 |
| 250x182 | 275x200 | 300x218 | 350x256 | 400x290 | 450x328 | 500x363 | 550x400 | 600x436 | |

Fiamma Norvegese cucita . Sewn Norwegian pennant - Misure (cm x cm) · Sizes (cm x cm)

| | | | | | | | | | |
|-----|-----|-----|-----|-----|-----|-----|-----|-----|-----|
| 50 | 65 | 75 | 100 | 125 | 150 | 175 | 200 | 225 | 250 |
| 275 | 300 | 350 | 400 | 450 | 500 | 550 | 600 | | |

Art. 98B Bandiere Regionali Olandesi - Dutch Regional Flags

Bandiere delle regioni Olandesi realizzate in tessuto stammina di poliestere 100%, confezionate con doppio orlo perimetrale, guaina di rinforzo e sagola per affissione all'asta. Misure disponibili nella tabella sottostante.

Dutch subnational Flags made of 100% woven polyester with double hem, sheath and rope.

Sizes available in the table below.

Brielse Geus



Drenthe



Flevoland



Friesland



Friesland Pennant



Gelderland



Geus Holland



Groningen



Limburg



Noord-Brabant

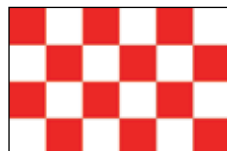

Noord-Holland



Overijssel



Utrecht



Zeeland



Zuid-Holland



Misure (cm x cm) · Sizes (cm x cm)

20x30

30x45

40x60

50x75

Art. 85B Bandiere Regionali Spagnole - Spanish Regional Flags

Bandiere delle regioni Spagnole realizzate in tessuto stammina di poliestere 100%, confezionate con doppio orlo perimetrale, guaina di rinforzo e sagola per affissione all'asta. Misure disponibili nella tabella sottostante.

*Spanish regional flags made of 100% woven polyester with double hem, sheath and rope.
 Sizes available in the table below.*



Misure (cm x cm) · Sizes (cm x cm)

| | | | | | | | | | |
|-------|-------|-------|-------|--------|--------|---------|---------|---------|---------|
| 20x30 | 30x45 | 40x60 | 50x75 | 70x100 | 80x120 | 100x150 | 130x200 | 150x225 | 200x300 |
|-------|-------|-------|-------|--------|--------|---------|---------|---------|---------|

Art. 16B Gran Pavese - International Code Flags Set

Gran Pavese completo, composto da 40 bandiere di segnalazione del Codice Internazionale, realizzato in tessuto stammina di poliestere 100% o poliestere economico, confezionato con doppio orlo perimetrale, guaina di rinforzo e sagola per affissione all'asta. Misure disponibili nella tabella sottostante.

International Code Flags Set, composed of 40 flags of the International Code, made of 100% woven or economical polyester with double hem, sheath and rope. Sizes available in the table below.

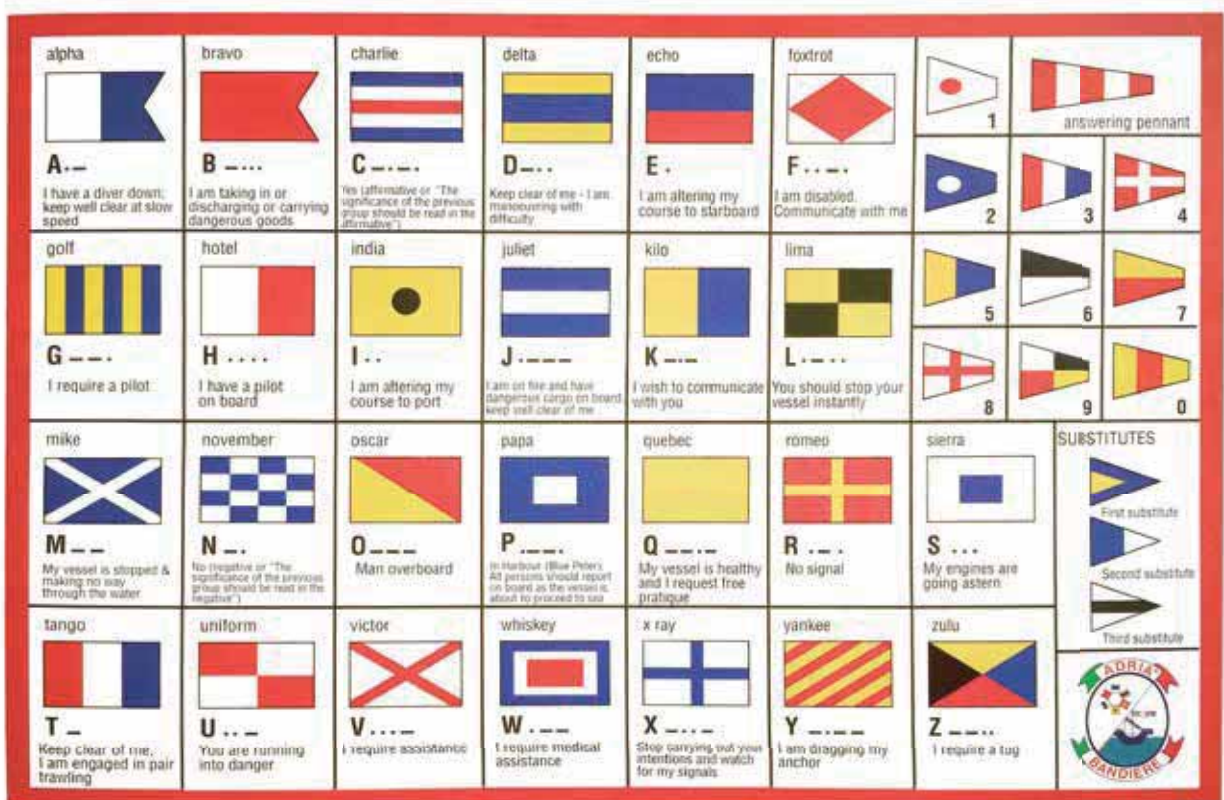

| Tessuto . Textile | Misure (cm x cm). Sizes (cm x cm) | | |
|--|--------------------------------------|---------|---------|
| Poliestere Economico Economic Polyester | 14x20 | 20x30 | 30x45 |
| Stamina di poliestere Woven polyester | 20x30 | 30x45 | 40x60 |
| | 50x70 | 60x73 | 80x120 |
| | 100x150 | 120x160 | 140x170 |

Art. 18B Contenitore Gran Pavese - International Code Flags Set Bag

Contenitore per Gran Pavese completo, realizzato in tessuto di cotone 100%.

100% cotton bag for International Code Flags Set.

Art. 17B Lettera "A" Segna Sub - Diving letter - "A" signal flag

Bandiera Segna Sub, sub in immersione, realizzata in stammina di poliester 100% e confezionata con doppio orlo perimetrale, guaina di rinforzo e sagola per affissione all'asta. Misure disponibili nella tabella sottostante.

Diving "A" signal flag made of 100% woven polyester with double hem, sheath and rope. Sizes available in the table below.



Misure (cm x cm) · Sizes (cm x cm)

| | | | | | | | | | |
|-------|-------|-------|-------|-------|-------|--------|---------|---------|---------|
| 20x30 | 30x45 | 40x60 | 50x70 | 60x73 | 80x98 | 80x120 | 100x150 | 120x160 | 140x170 |
|-------|-------|-------|-------|-------|-------|--------|---------|---------|---------|

Art. 19B Bandiera Segna Sub - Diver Down Flag

Bandiera Segna Sub, diving in immersione, realizzata in stammina di poliester 100%, confezionata con doppio orlo perimetrale, guaina di rinforzo e sagola per affissione all'asta. Misure indicate nella tabella sottostante.

Diver down signal flag made of 100% woven polyester with double hem, sheath and rope. Sizes available in the table below.



Misure (cm x cm) · Sizes (cm x cm)

| | | | | | | | | | |
|-------|-------|-------|-------|--------|--------|---------|---------|---------|---------|
| 20x30 | 30x45 | 40x60 | 50x75 | 70x100 | 80x120 | 100x150 | 130x200 | 150x225 | 200x300 |
|-------|-------|-------|-------|--------|--------|---------|---------|---------|---------|

Art. 23B Confezioni con Blister - Blister packaging

Su richiesta le bandiere vengono fornite in blister con cartoncini personalizzati

On request customized blister packaging.



Art. BLISTBO Scatola per Gran Pavese - Storage box for International Code Flag Set

Scatola in plastica per codice internazionale nelle misure 20x30, 30x45 in tessuto economico e 20x30 in tessuto stammina.

Plastic storage box for I.C. set 20x30, 30x45 in economic polyester and 20x30 in woven polyester.



Art. 51B Bandiere Comunità Europea con Inserto - European Community Flags

Bandiera della Comunità Europea, con inserto bandierina dello Stato Comunitario, realizzata in tessuto stamina di poliestere 100%, confezionata con doppio orlo perimetrale, guaina di rinforzo e sagola per affissione all'asta.

European community flag, with the Participating Country, made of 100% woven polyester, with double hem, sheath and rope.



Art. 45B01 Tabella del Codice Internazionale - International Code Board

Tabella ornamentale del codice internazionale stampata a freddo, a rilievo su legno o forex nella mis. 30x40 cm.

International code board on wood or forex, size 30x40 cm.



Art. 45B02 Tavola con Rosa dei Venti - Compass Card Board

Tabella ornamentale stampata con disegno della Rosa dei Venti a rilievo, anche personalizzata, su legno o forex nella mis. 25x25.

Compass card board printed on wood or forex, size 25x25.



Art. 99B Pochette "N" e "C" e Francia - Flag letter "N" and "C" and France with clutch bag

Kit pochette completo di bandiere di segnalazione "N" e "C" e Francia, secondo regolamento Francese, realizzate in tessuto poliestere economico pongé, confezionate con doppio orlo perimetrale, guaina di rinforzo e sagola per affissione all'asta. Misure disponibili nella tabella sottostante.

Kit of "N" and "C" signaling and french flags, made of economic polyester with double hem, sheath and rope, complete with bag. Sizes available in the table below.

Misure (cm x cm) · Sizes (cm x cm)

30x40

50x60

Art. 15B Guidone di Venezia (San Marco) - Venetian (San Marco) Pennant

Guidone di Venezia realizzato in tessuto stammina di poliestere 100%, confezionato con doppio orlo perimetrale, guaina di rinforzo e sagola per affissione all'asta. Misure disponibili nella tabella sottostante.

Venetian Pennant made of 100% woven polyester with double hem on edge, sheath and rope. Sizes available in the box below.



Misure (cm x cm) · Sizes (cm x cm)

| | | | | |
|-----------------------|--------------------------------|--------------------------------|-------------------------|--------------------------|
| 12x24 (code unite) | 22x44 (code unite e divise) | 30x60 (code unite e divise) | 55x130 (code divise) | 100x190 (code divise) |
|-----------------------|--------------------------------|--------------------------------|-------------------------|--------------------------|

Art. 27B Bandiere di Fantasia - Fun Flags

Bandiere di fantasia realizzate in tessuto stammina di poliestere 100%, confezionate con doppio orlo perimetrale, guaina di rinforzo e sagola per affissione all'asta. Misure disponibili nella tabella sottostante.

Fun flags made of 100% woven polyester, with double hem, sheath and rope. Sizes available in the table below.

| | | | | | |
|--|---|--|---|---|--|
| <i>Blue Marlyn - GR3</i>  | <i>Coffee Time - GR3</i>  | <i>Dancing on Board - GR4</i>  | <i>Do not Disturb - GR3</i>  | <i>Drinking Beer - GR3</i>  | <i>Drinking Champagne - GR2</i>  |
| <i>Drinking Cocktail - GR2</i>  | <i>Drinking Wine - GR2</i>  | <i>Free Heart - GR4</i>  | <i>Guest on Board - GR4</i>  | <i>Jolly Roger White - GR2</i>  | <i>Jolly Roger Black - GR2</i>  |
| <i>Mother in Law on Board Danger - GR3</i>  | <i>Newly Weds on Board - GR2</i>  | <i>No Wife on Board - GR3</i>  | <i>Playing Cards - GR3</i>  | <i>Private Property - GR3</i>  | <i>Sea horse - GR3</i>  |
| <i>Shark - GR2</i>  | <i>Tuna Fish - GR2</i>  | <i>Wife on Board - GR2</i>  | | | |

Misure (cm x cm) · Sizes (cm x cm)

| | |
|-------|-------|
| 20x30 | 30x45 |
|-------|-------|

Art. 23B Guidoni Sociali - Customized Pennants

Guidoni personalizzati per clubs realizzati in tessuto stammina di poliestere 100% o poliestere nautico, confezionati con doppio orlo perimetrale, guaina di rinforzo e sagola per affissione all'asta, stampati a colori sia in serigrafia che in digitale, con stampa passante o due dritti cuciti insieme. Misure su richiesta.

Customized pennants made of 100% woven or knitted polyester with double hem, sheath and rope, screen or digital printed with passing system or on both sides (two straights). Sizes on request.



Art. 46B Adesivi - Stickers

Adesivi Tabella del Codice Internazionale o singole lettere, Italia Mercantile, Tabella Paesi del Mediterraneo e bandiere assortite nazionali e mercantili, stampati a freddo su PVC per esterno con colori resistenti. Misure disponibili indicate nella tabella sottostante.

Stickers of International Code set or single letters, Italian Civil Ensign or table of Mediterrean nations and assorted civil or national flags, cold-printed on PVC for outdoor use with resistant colors. Available sizes in the table below.



Misure (cm x cm) · Sizes (cm x cm)

11x16,5

15x21

16,5x25

20x30

Art 22B Bandiere Personalizzate Verticali- Customized Vertical Flags

Bandiere personalizzate, formato verticale, realizzate in tessuto stammina di poliestere 100% o poliestere nautico, stampa serigrafica o digitale passante a colori, confezionate con doppia orlatura perimetrale, guaina di rinforzo e sagola per affissione all'asta o, per struttura con braccio, confezionate con asola in alto e ganci all'asta.

Customized flags, vertical shape, made of 100% woven polyester or knitted polyester, digital or screen printing, with double hem, sheath and rope or, for rotating aluminium bar, loop on the top and hooks at the pole.



Art 22B Bandiere Personalizzate Orizzontali - Customized horizontal flags

Bandiere personalizzate, formato orizzontale, realizzate in tessuto tecnico per esterno, stammina di poliestere 100%, poliestere nautico o ponge', stampa passante a colori serigrafica o digitale, confezionate con doppia orlatura perimetrale, guaina di rinforzo e sagola per affissione all'asta oppure con tasca per inserimento asta, o occhielli a vela, o nastri per affissione all'asta.

Customized horizontal flags, made of 100% woven polyester or knitted polyester or ponge', digital or screen printing, with double hem, sheath and rope or hole to insert the pole or eyelets or laces for hanging.



Tessuto Stamina

Tessuto Pol. Nautico

Tessuto Pongè

Tessuto Raso Pesante



Art. 22B Bandiere Orizzontali Economiche - Customized Horizontal Economic Flags

Bandiere personalizzate, formato orizzontale realizzate in tessuto di poliestere economico o twill, stampa passante serigrafica o digitale a colori, confezionate con orlatura perimetrale singola, asola laterale o nastri per affissione ad asta.

Customized horizontal flags made of economic polyester or twill, digital or screen printed, with double hem, sheath and rope.



Art. 22BV Bandiere a vela (Beach flags)-

Sail Flags

Bandiere personalizzate formato a vela, realizzate in tessuto poliestere nautico con stampa digitale passante a colori ed effetto speculare, non orlate ma rifinite con asola di lycra elastica per inserimento asta flessibile. Misure disponibili nella tabella sottostante.

Custom advertising sail shape flags, made of knitted polyester, digitally printed with slot for pole insertion. Sizes available in the table below.

| Misure bandiere a vela | |
|------------------------|--------|
| SP | 60x200 |
| S | 60x260 |
| M | 75x350 |
| L | 85x450 |

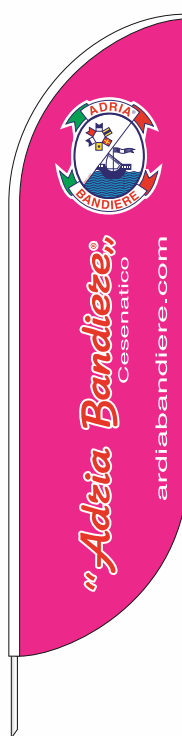

Art. 22BG Bandiere a goccia

(Beach flags)- Drop Flags

Bandiere personalizzate formato a goccia, realizzate in tessuto poliestere nautico con stampa digitale passante a colori ed effetto speculare, non orlate ma rifinite con asola di lycra elastica per inserimento asta flessibile. Misure disponibili nella tabella sottostante.

Custom advertising drop shape flags, made of knitted polyester, digitally printed with slot for pole insertion. Sizes available in the table below.

| Misure bandiere a goccia | |
|--------------------------|---------|
| SP | 80x160 |
| S | 100x200 |
| M | 130x270 |
| L | 130x390 |



Art. Kit per Beach Flag - Beach Flag Kit

Kit completo per beach flags a vela o goccia composto di asta in alluminio divisa in sezioni, con cimino pieno in vetroresina flessibile, base in ferro cromato a X ripiegabile con perno rotante, zavorra in PVC da riempire ad acqua e 1 borsa in nylon per trasporto. La bandiera è esclusa dal kit.

The kit includes one aluminium pole, divided in sections, with fiberglass flexible, one chromed plated steel crossed base and one nylon carrying bag. The flag is not included in the kit.



Art. 38BV01 Base in Cemento - Concrete Base

Base autoportante in cemento ricoperto con plastica di PVC nero ad un innesto centrale per asta da beach flags, misura 40x40x10 cm, peso kg. 30.

Self-supporting concrete base covered with black PVC for one aluminium pole for beach flags.



Art. 38BV03G Base in Plastica - Plastic Base

Base rotonda in plastica grigia con piedini, da riempire con acqua, ad un innesto centrale con perno rotante per asta da beach flags peso kg. 11.

Black round empty PVC base with rotating support for beach flags.



Art. 37B31 Asta per Beach Flags - Beach Flags Pole

Asta in alluminio telescopica per beach flags, divisa in sezioni con innesto a baionetta e cimino terminale in vetroresina flessibile, disponibile in tre misure: mt. 3,5/4,5/5,5 per misure beach flags S, M, L.

Telescopic aluminium pole, divided in sections, for beach flags available in three different sizes: mt. 3,5/4,5/5,5 for beach flags S, M, L.



Art. 38BV02 Base a Vite - Base With Rotating Support

Base in pvc a vite con perno rotante per terreni morbidi

Screw pvc base with rotating pin for soft ground.



Art. 38BV05 Picchetto per Beach Flags - Hot Galvanized Base for Beach Flags

Picchetto in ferro zincato a caldo ad innesto per aste da beach flags.

Iron hot galvanized base for beach flags for sand or soft lands.



Art. 38BV07 Piantana sottoruota per Beach Flags - Under Wheel Base for Beach Flags

Piantana sottoruota in ferro verniciato per aste da beach flags.

Under wheel base in silver painted steel for beach flags.



Art. 22BVXS

Kit per interno completo di bandiera a vela XS (misura 50x180, altezza finita 210 cm circa) realizzata in tessuto poliestere nautico, personalizzata con stampa digitale passante a colori, asta in alluminio da 240 cm con innesto a baionetta e cimino terminale flessibile, base in ferro verniciato nero rettangolare e borsa nera in nylon per il trasporto. Peso totale kg 1,2 circa.

Kit for internal use complete of XS flag (size 50x180), made of knitted polyester, customized with digital passing printing. Aluminium pole of 240 cm with bayonet grafting and flexible tip, rectangular iron black printed base and nylon black bag. Total weight 1,2 kg.



Art. 22BGXS

Kit per interno completo di bandiera a goccia XS (misura 60x140, altezza finita 180 cm circa), realizzata in tessuto poliestere nautico, personalizzata con stampa digitale passante a colori, asta in alluminio da 240 cm con innesto a baionetta e cimino terminale flessibile, base in ferro rettangolare verniciato nero e borsa nera in nylon per il trasporto. Peso totale kg 1,2 circa.

Kit for internal use complete of XS flag (size 60x140), made of knitted polyester, customized with digital passing printing. Aluminium pole of 240 cm with bayonet grafting and flexible tip, rectangular iron black printed base and nylon black bag. Total weight 1,2 kg.



Art. 25BRU Roll-up

Struttura roll-up in alluminio autoavvolgente completa di telo monofacciale personalizzato in tessuto di poliestere pesante, stampato a colori e completo di borsa in nylon nera per il trasporto. Misura disponibile 80 x 200 cm.

Roll-up display with auto-wrapping aluminium structure complete with single side customized cloth, made of heavy polyester textile, and carry bag. Available size: 80 x 200 cm.



Art. 25BF Stendardo - Banner

Pannello standardo personalizzato in tessuto poliestere, mono o bifacciale, completo di struttura auto portante in alluminio con braccio orizzontale e base in ferro zincato. Misure disponibili nella tabella sottostante.

Self-supporting customized banner made of technical polyester, printed on both sides, with self-supporting aluminium stand, complete with pole and arm and iron base. Sizes available in the table below.



| Misure (cm x cm) · Size (cm x cm) | |
|-----------------------------------|----------|
| 75/100x160 | asta 2 m |
| 75/100x260 | asta 3 m |

Art. 25BP Stendardo - Banner

Stendardo personalizzato realizzato in tessuto di poliestere, mono o bifacciale, con appoggio a parete, confezionato con taglio a caldo sui lati, asola passante in alto per traversino in PVC o legno con fune o con occhielli a vela in metallo sul perimetro.

Customized wall banner, made of polyester, printed on one or two sides, with wall support, sewn with hot cut or hem and a loop on the top of PVC spring line and passing rope or metallic eyelets on edge.



Art. 25BH Stendardo - Banner

Pannello stendardo in tessuto poliestere, bi facciale, per esterno, ricamato a macchina o stampato, completo di asta in alluminio e attacco murale.

Customized banner made of polyester, for outside, machine embroidered or printed, with aluminium pole and iron wall attachment.



Art. 25BA Kit Espositivo con bandiera - Exhibition Kit with Flag

Kit espositivo con asta in alluminio da mt 3, braccio fisso da cm 75 e base in metallo verniciato.

Exhibition kit with aluminium pole of 3 mt, fixed arm of 75 cm and base in painted metal.



La bandiera, cm 220x75, è stampata su tessuto poliestere nautico (peso 110 gr al mq +/- 5%) con sistema digitale passante (sul retro effetto speculare) e confezionata con doppio orlo perimetrale e asola nella parte superiore e nella parte laterale.

The flag, cm 220x75, is printed on knitted polyester (weight 110 gr to sqm +/- 5%) with digital passing system (reading correctly from the front side with the mirror image on the reverse) finished with double perimeter hem and eyelet in the upper and lateral side.



Art. 64B03 Bandiera Personalizzata in Raso di Poliestere - Customized Satin Flag

Bandiera personalizzata in raso di poliestere, dim. cm. 100x150, con frangia dorata o argentata in canuttiglia da 10 mm, ricamata a macchina.

Customized satin flag, size cm. 100x150, with gold or silver fringe of mm. 10, embroidered with machine.



Art. 64B07 Bandiera Italiana in Raso di Poliestere - Italian Polyester Satin Flag

Bandiera Italia nazionale in raso di poliestere pesante, due teli stampati e cuciti insieme, con doppio orlo perimetrale, nastri di raso all'asta e frangia su richiesta, dim. cm. 100x150.

Italian flag made of polyester satin fabric, two fully printed sewn sheets. Double hem, satin pole ribbons and fringe on request



Art. 03B01 Set Bandiera Italiana in Seta - Italian Silk Flag Set

Set per ufficio composto da una bandiera italiana con tricolore cucito in pura seta, dim. 100x150 con frangia metallica dorata, base a 1 innesto e asta in ottone cromato divisibile in sezioni con montaggio per avvitamento, h. cm. 225 e lancia generica in ottone lucido.

Office set composed of one Italian pure silk flag, size cm. 100x150, with gold fringe, chrome brass base, a brass pole and a brilliant gold ferrule.



Art. 64B07 Bandiera C.E. in Raso di Poliestere - C.E. Polyester Satin Flag

Bandiera C.E. in raso di poliestere pesante, due teli stampati e cuciti insieme, con doppio orlo perimetrale, nastri di raso all'asta e frangia su richiesta, dim. cm. 100x150.

C.E. flag made of polyester satin fabric, two fully printed sewn sheets. Double hem, satin pole ribbons and fringe on request



Art. 03B06X Set per Ufficio - Flag For Office Use

Set completo per ufficio composto da una bandiera italiana con tricolore cucito, una bandiera della C.E. con stelle ricamate a macchina e una bandiera regionale con stemma applicato, dim. 100x150 con frangia metallica dorata, base in ferro cromato a tre innesti e n. 3 aste in ottone cromato divisibili in sezioni con montaggio per avvitamento, h. cm. 225 e tre lance generiche in ottone lucido.

Office set composed of Italian, C.E. and regional flag in pure silk, size cm. 100x150, with gold fringe, chrome iron base, three chrome iron poles 225 cm and three brilliant gold ferrules.



Art. 03B04 Set Bandiera Italiana in Poliestere - Italian Polyester Flag Set

Set per ufficio composto da una bandiera italiana stampata in tessuto stamina di poliestere 100%, dim. 100x150, confezionata con doppio orlo perimetrale, guaina di rinforzo e sagola per affissione all'asta, base in ferro cromato con anima pesante interna, asta in ferro cromato da h. cm. 225 diam. mm. 22, divisibile in tre parti con montaggio per avvitamento e pomolo a sfera in ottone lucido.

Office set composed of Italian woven polyester flag, size cm. 100x150, with double hem, sheath and rope, chrome plated iron base, chrome plated iron pole of 225 cm., diam. mm. 22, and divided in three parts with a brilliant gold brass ferrule.



Art. 03B05 Set Bandiera C.E. in Poliestere - C.E. Polyester Flag Set

Set per ufficio composto da una bandiera C.E. realizzata in tessuto stamina di poliestere 100% dim. 100x150, confezionata con doppio orlo perimetrale, guaina di rinforzo e sagola per affissione all'asta, base in ferro cromato con anima pesante interna, asta in ferro cromato da h. cm. 225 diam. 22 divisibile in tre parti con montaggio per avvitamento e pomolo a sfera in ottone lucido.

Office set composed of C.E. woven polyester flag, size cm. 100x150, with double hem, sheath and rope, chrome plated iron base, chrome plated iron pole of 225 cm., diam. mm. 22 and divided in three parts with a brilliant gold brass ferrule.



Art. 03B06 Set bandiera Italiana e C.E. in poliestere - Polyester Italian and C.E. Flag Set

Set per ufficio composto da una bandiera italiana e una bandiera della C.E. in tessuto stamina di poliestere 100%, dim. 100x150, confezionata con doppio orlo perimetrale, guaina di rinforzo e sagola per affissione all'asta, completo di base in ferro cromato a due innesti, due aste in ferro cromato da h. cm. 225 e diam. mm. 22 divisibili in tre parti con montaggio per avvitamento e due pomoli a sfera in ottone lucido.

Office set composed of one Italian and C.E. flags made of polyester, size cm. 100x150 with chrome plated iron base for two chrome plated poles of 225 cm high, diam mm. 22, divided in three parts and with two brilliant gold brass ferrules.



Art. 61B Gonfaloni/Stendardi- Banners

Gonfaloni o stendardi ricamati a macchina o stampati, realizzati in tessuto di seta pura, moella di viscosa o raso pesante di poliestere, completi di passamaneria e frangia, con retro in tinta neutro. Misure e formati su richiesta.

Printed or machine embroidered banners, made of pure/synthetic silk or polyester with trimmings and fringe and neutral back. Sizes and shapes on request.



Art. 44B11 Cinturone - Belt

Cinturone in nylon per sostegno di asta da parata.

Nylon belt in order to hold poles.



Art. 44B01 Borsa per Kit da Interno - Bag for Indoor Kit

Borsa in nylon pesante per il trasporto di kit (da interno) completo per bandiera di rappresentanza con asta, lancia e base.

Nylon carry case for inside flag with pole, ferrule and base.



Art. 44B02 Borsa per gonfalone - Banner's bag

Borsa in nylon pesante per il trasporto di gonfalone e accessori.

Nylon carry case for banner and accessories.



Art. 02B01 Fascia da Sindaco Ricamata a Macchina - **Machine Embroidered Mayor Sash**

Fascia tricolore da sindaco in grogré di moella di viscosa, con stemma della Repubblica Italiana e corona con fronde modello standard, ricamata a macchina sul nastro e stemma personalizzato del Comune stampato su raso e applicato, con nodo semplice o fiocco e frangia di canuttiglia sia oro che argento da 12 cm.

Mayor sash embroidered with machine with knot or bow and silver or gold fringe.

Particolare confezione con fiocco
Detail of finishing with bow



Particolare stemma stampato e applicato
Emblem printed and applied



Particolare stemma ricamato a macchina
Emblem entirely embroidered



Art. 02B22 Fascia da Presidente della Provincia - **District's President sash**

Fascia azzurra da Presidente della Provincia ricamata a macchina, in nastro di grogré di viscosa con fiocco e frangia oro in canuttiglia da 12 cm.

District's President light blue sash machine embroidered with knot or bow with gold fringe of 12 cm.



Art. 05B02 Fiocco a lutto - **Mourning Ribbon**

Fiocco a lutto in grogré di viscosa nera con frange metalliche oro o argento da 2,5 cm per bandiere da interno.

Mourning ribbon made of black viscose with silver or gold fringe of 2,5 cm for indoor flags.



Art. 05B01 Fiocco tricolore - **Italian Ribbon**

Fiocco tricolore in grogré di viscosa con frange metalliche oro o argento da 2,5 cm per bandiere da interno.

Tricolored Italian ribbon made of viscose with silver or gold fringe of 2,5 cm for indoor flags.



Art. 05B03 Nastro Ricamato - **Embroidered Ribbon**

Nastro ricamato personalizzato realizzato in tessuto grogré h. cm. 10, ricamato a macchina in filo oro metallico, con frangia oro metallico da 2,5 cm, per bandiere da interno o per gonfalone.

Embroidered ribbon made of grogré h. cm. 10, machine embroidered, with metallic gold fringe of cm 2.5 for indoor flags or banners.



Art. 54B03 Coccarda da Giacca - Jacket Cockade

Coccarda da giacca, diametro 5 cm, in nastro tricolore in grogré di poliestere, completa di spilla da balia in metallo sul retro con o senza code.

Jacket cockade, diam. cm. 5, complete of metal safety pin on the back.

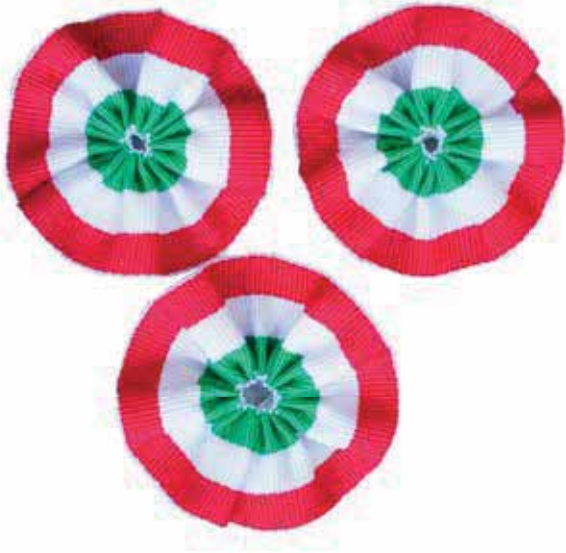

Art. 54B01/02 Coccarda in Tessuto - Cockade

Coccarda in tessuto con cerchio di sostegno in metallo e nastri sul retro per palco premiazione. Disponibile in vari formati.

Polyester cockade with metallic circle for support and bands on the back side. Available in different sizes.



Art. 30B01 Bandierine da Tavolo - Small Table Flags

Bandierine di nazioni da tavolo, dim. cm. 14x21, realizzate in tessuto poliestere nautico, stampa passante e tagliate al vivo sui lati senza orlo, con asola laterale per astina (non compresa).

Small table national flags, size cm. 14x21, made of rayon or knitted polyester material, passing printing, without hem but with loop for little pole (not included).



Art. 30B02 Bandierine da Tavolo Personalizzate - Customized Table Flags

Bandierine personalizzate da tavolo, disponibili in vari formati, realizzate in diversi tessuti, raso singolo o doppio, poliestere nautico con stampa digitale passante, moella stampata o ricamata a macchina anche con frangia sui lati, e asola laterale per l'inserimento dell'astina (non compresa).

Customized table flags, different sizes, made of single or double side satin material, or printed knitted polyester or hand/machine embroidered moella with fringe on edge and side loop for little pole (not included).



Art. 30B03 Bandierine Personalizzate - Customized Flags

Bandierine personalizzate, mis. cm. 9x13 singole o doppie, realizzate in tessuto di raso di poliestere o in poliestere nautico con stampa digitale a colori passante, confezionate con asola laterale e complete di astina da tavolo h. cm. 23 in legno naturale con pallina terminale e basetta da tavolo singola o a più innesti.

Customized table flags, cm. 9x13, made of single or double side satin material or knitted polyester with passing printing, with pole side loop sewn and wooden pole cm. 23, small wooden ferrule and small table base for one or several grafts.









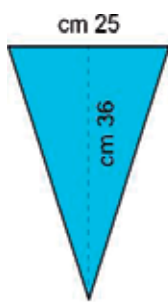

Art. 29B Gagliardetti - Social Pennants

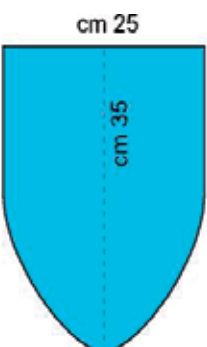
Gagliardetti personalizzati, realizzati in tessuto di raso o moella di viscosa, stampati in serigrafia o digitale o ricamati a macchina, di varie dimensioni e formati, confezionati con traversino con borchie laterali in ottone, cordino, frangia, passamaneria e busta sagomata in PVC trasparente. Misure disponibili nella tabella sottostante.

Customized social pennants, made of brilliant or stiff satin, or synthetic silk, digital or sewn printing or machine embroidered, several sizes and shapes, completed with fringe, trimming and plastic shaped bag. Sizes available in the table below.



| | | | | | | | |
|---|---|---|---|--|---|---|---|
|  |  |  |  |  |  |  |  |
| Art. 29B40 | Art. 29B42 | Art. 29B43 | Art. 29B44 | Art. 29B45 | Art. 29B46 | Art. 29B48 | Art. 29B49 |

Art. 21B01 Sciarpe Personalizzate- Customized Scarfs

Sciarpe personalizzate, realizzate in lycra stampate ad alta risoluzione su due lati e confezionate con frangia h. cm. 4. alle estremità, oppure in tessuto di poliestere con stampa passante con o senza orlo.

Customized scarfs, made of lycra, printed on both sides and complete with fringe h. cm. 4 or made of polyester with passing printing with or without hem.



Art. Foulard

Foulard personalizzato, stampato a colori con stampa passante, confezionato con orlo semplice sui lati, realizzato in tessuto poliestere pongé' o twill. Dimensioni su richiesta.

Customized foulard, printed with colors, simple hem on sides, made of polyester pongé' or twill. Different sizes on request.



Art. 31B01 Bandierine di Nazioni da Sventolare - National Waving Flags

Bandierine di nazioni da sventolare, dim. cm. 20x30, realizzate in materiale plastico, polietilene, con taglio al vivo sui lati, complete di astina in PVC da cm. 45 e puntalino di sicurezza.

National waving flags, size 20x30 cm, made of polyethylene, with a 45 cm PVC little pole.



Art. 31B02 Bandierine Personalizzate da Sventolare - Customized Waving Flags

Bandierine personalizzate da sventolare, dim. cm. 14x21 o 20x30, realizzate in tessuto poliestere economico, pongè o poliestere nautico (senza orlo perimetrale) con stampa passante a colori e confezionate con taglio a caldo sui lati e astina in PVC da cm. 45.

Waving national or customized flags, size 14x21 or 20x30 cm, made of economic polyester or pongè or knitted polyester without hem on edge and included a 45 cm PVC little pole.



Art. 31B03 Bandierine Personalizzate da Sventolare - Customized Waving Flags

Bandierine personalizzate da sventolare, dim. 15x22 o 20x30, realizzate in materiale plastico, diverse grammature, stampate a colori su due lati, tagliate al vivo e confezionate con astina in PVC da cm. 45.

Waving customized flags, size cm. 15x22 or 20x30, made of plastic material for outside use, printed on both sides, net cut on edge with PVC pole cm. 45.



Art. 20B01 Festone con Bandiere Colorate - **Festoon of Colored Flags**

Festone composto da 28 bandiere triangolari in PVC, misura cm. 20x30, di colori alternati, montate su guaina con lunghezza totale 10 mt.

Festoon composed of 28 triangular PVC flags, size 20x30 cm, with alternating colors, total length mt. 10.



Art. 20B02 Festone con Bandiere di Nazioni - **Festoon of National Flags**

Festone composto da 28 bandierine rettangolari di nazioni assortite, misura cm. 20x30, realizzate in tessuto staminta di poliestere 100%, confezionate con orlo perimetrale e montate su guaina con lunghezza totale 10 mt.

Festoon composed of 28 flags of nations, size 20x30 cm, made of 100% woven polyester, with double hem, total length mt. 10



Art. 20B03 Festone con Bandiere di Nazioni - **Festoon of National Flags**

Festone composto da 15 bandiere rettangolari di nazioni assortite, misura cm. 14x21, realizzate in tessuto poliestere, tagliate a caldo sui lati, non orlate e montate su guaina con lunghezza totale 5 mt.

Festoon composed of 15 rectangular flags of nations, size 14x21 cm, made of polyester, total length mt. 5.

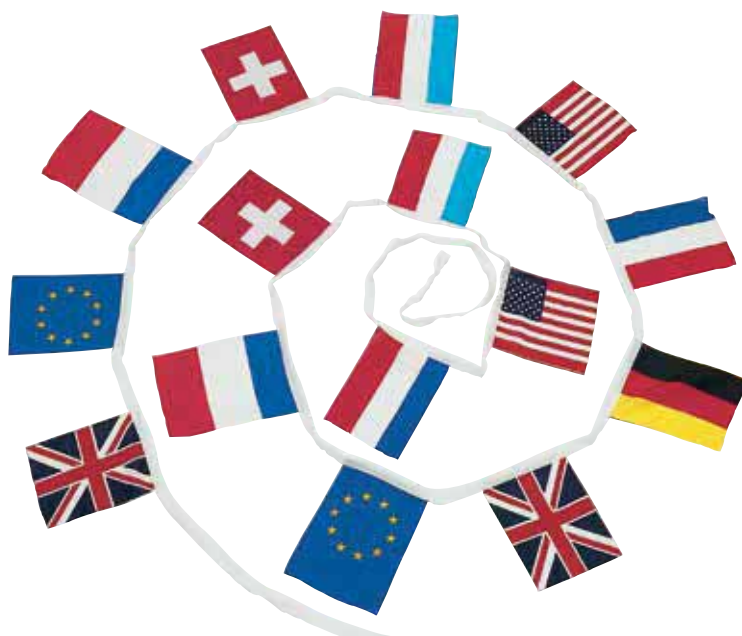

**Art. 20B04 Festone con
Bandiere di Nazioni -
Festoon with National Flags**

Festone composto da 24 bandiere rettangolari di nazioni assortite, misura cm. 20x30, in materiale plastico polietilene, montate su fettuccia di tnt con lunghezza 10 mt.

Festoon composed of 24 rectangular flags of nations, size 20x30 cm, made of polyethylene, total length mt. 10.



**Art. 20B05 Festone con
Bandiere Colorate - Festoon
With Colored Flags**

Festone composto da 24 bandiere triangolari in materiale plastico polietilene, dim. cm. 20x30, di colori alternati, montate su fettuccia di tnt con lunghezza totale 10 mt.

Festoon composed of 24 triangular flags, size 20x30 cm, made of polyethylene, with alternating colors total length mt. 10.



Art. 20B06 Festone Personalizzato - Customized Festoon

Festone composto da bandiere personalizzate di diverse dimensioni, realizzato in materiale per esterno (sia tessuto che PVC).

Customized festoon, different sizes, made of suitable outdoor material (both textile or PVC).



Art. 44B30 Borsa Personalizzata - Customized Bag

Borsa personalizzata, modello "Shopper", realizzata in tessuto canvas di poliestere, stampa digitale all-over, misura cm. 40x50x19, con manici, tasche interne e fondo rigido.

Customized bag, made of canvas, all-over digital printing, size cm. 40x50x19, handles, internal pockets and hard bottom.



Art. 21BPO Pochette

Pochette (astuccio) personalizzata, realizzata in tessuto canvas di poliestere, stampa digitale all-over, misura cm. 15x24.

Customized pochette, made of canvas, all-over digital printing, size cm. 15x24.



Art. 21BZ Zaino - Backpack

Zaino personalizzato modello sacca, realizzato in tessuto canvas di poliestere, stampa digitale all-over, misura cm. 35x45.

Customized backpack, made of canvas, all-over digital printing, size cm. 35x45.



Art. 44B30 Borsa e Zaino Shopper - **Shopper Bag and Backpack**

Borsa personalizzata, modello "Shopper", realizzata in tessuto taffetà di poliestere, stampa digitale all-over, misura cm. 38x45, con manici e tasca interna per ripiegarla su se stessa.

Zaino personalizzato realizzato in tessuto taffetà di poliestere, stampa digitale all over, misura cm. 32x44, con corda e tasca interna per ripiegarlo su se stesso.

Customized bag, made of taffetta, all-over digital printing, size cm. 38x45, handles and internal pocket.

Customized backpack, made of taffetta, all-over digital printing, size cm 32x44, handles and internal pocket.



Art. 21BCU Copri Cuscino Personalizzato - **Customized Pillow Cover**

Copri cuscino personalizzato, realizzato in tessuto poliestere ponge' misura 33x33x2 oppure in tessuto canvas 50x50, realizzato con stampa digitale all-over confezionato con cerniera laterale.

Customized pillow cover, made of economic polyester size 33x33x2 or canvas size 50x50, all-over digital printing and complete with lateral zip.



Art. 01A17D Bandiera Personalizzata con attacchi a palo della luce -Customized Flag with Attachments for Light Pole

Bandiera personalizzata, dim. cm. 250x70, realizzata in tessuto poliestere nautico, completa di coppia di staffe per palo della luce con piastra a misura e fascette in acciaio.

Customized knitted polyester flag, size cm. 250x70, complete with a pair of pole brackets with customized plate and steel clamps.

Dettaglio retro - *Detail of the back*



Art. 31B04 Bandiera Personalizzata da Parete -Customized Wall Flag

Bandiera personalizzata, dim. cm. 30x45, realizzata sia in tessuto poliestere economico ponge' che PVC, completa di attacco murale con biadesivo e asta cm. 60 circa in PVC bianco.

Customized polyester or PVC flag, size cm. 30x45, with wall attachment, double-sided tape and white PVC pole of cm. 60.



Art. 31B05 Bandiera Personalizzata da Parete -Customized Wall Flag

Bandiera personalizzata, dim. cm. 20x30, realizzata sia in tessuto poliestere economico ponge' che PVC, completa di attacco murale con biadesivo e asta cm. 50 circa in PVC bianco.

Customized knitted or ponge' polyester flag, size 20x30 cm., with wall attachment, double-sided tape and PVC white pole of cm. 50.



Art. 43B01 Basetta in Ottone da 1 - Small Table Brass Stand for 1 Pole

Basetta da tavolo in ottone lucido o cromato, da 1 posto, diam. 8,6 cm., completa di astina in ottone h. cm. 40 e terminale a pallina.

Small table brass or chrome stand diam. cm. 8,6, with 1 pole, h.cm. 40.



Art. 43B03 Basetta in Ottone da 3 - Small Table Chrome Brass Stand for 3 Poles

Basetta da tavolo in ottone cromato, da 3 posti, diam. 8,6 cm., completa di astine in ottone h. cm. 40 e terminale a pallina.

Small table chrome brass stand, diam. cm 8,6, with 3 poles, h.cm. 40.

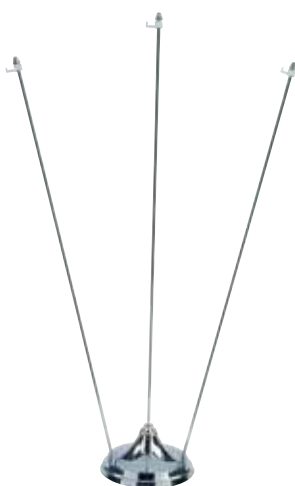

Art. 43B07 Basetta in Ottone da 13 - Small Table Brass Stand for 13 Poles

Basetta da tavolo in ottone cromato, da 13 posti, diam. 8,6 cm., completa di astine in ottone h. cm. 40 e terminale a pallina.

Small table chrome brass stand, with 13 poles, h.cm. 40.

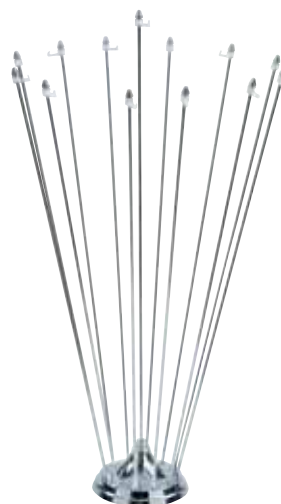

Art. 43B51 Astina per Finestrino - Window Car Flag Pole

Astina economica in PVC bianco da finestrino auto, h. cm. 45, per bandiera in tessuto dim. cm. 25x38.

Window car white PVC flag pole, h. cm. 45, for flag cm. 25x38.



Art. 43B10 Basetta in Legno da 1 - Small Table Wood Stand for 1 Pole

Basetta da tavolo in legno di faggio naturale a 1 posto, diam. 7,8 cm., completa di astina h. cm. 35 e terminale a pallina.

Small table wood stand, cm. 7,8, with 1 flag pole, h. cm. 35.



Art. 43B11 Basetta in Legno da 3 - Small Table Wood Stand for 3 Poles

Basetta da tavolo in legno di faggio naturale da 3 posti, diam. 7,8 cm., completa di 3 astine h. cm. 35 e terminali a pallina.

Small table wood stand, cm. 7,8, with 3 flag poles, h. cm. 35.



Art. 43B12 Basetta in Legno da 5 - Small Table Wood Stand for 5 Poles

Basetta da tavolo in legno di faggio naturale da 5 posti, completa di 5 astine h. cm. 35 e terminali a pallina.

Small table wood stand, with 5 flag poles, h.cm. 35.



Art. 43B50 Astina per Auto - Car Pole

Astina per auto per bandiera da parata in ottone cromato con attacco a vite o con magnete, h. cm. 40.

Chrome brass car flag pole, h. cm. 40, with screw connection or magnet.



Art. 37B Asta in ottone- Chrome Brass Flag Pole

Asta per bandiera o gonfalone in ottone lucido o cromato per basi da interno in ottone, in diverse altezze, divisa in sezioni con montaggio per avvitamento diam. mm. 22.

Chrome brass flag pole, for flag or banner, for indoor brass base, several lengths, divided in multiple sections, diam. mm. 22, with screw installation.

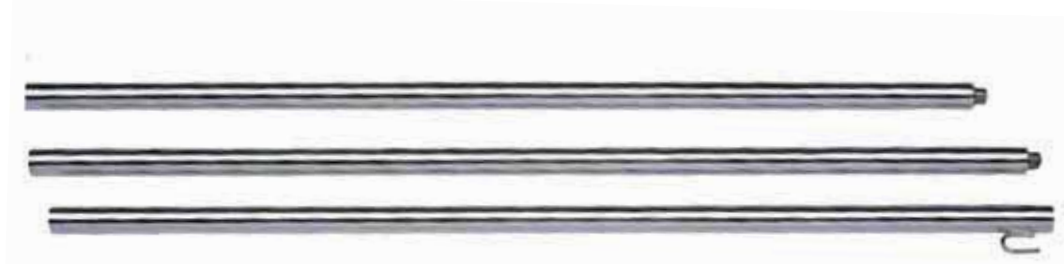

Art. 37BF Asta in Ferro Cromato - Chrome Iron Flag Pole

Asta per bandiera in ferro cromato per basi da interno, in diverse altezze, divisa in sezioni con montaggio per avvitamento, diam. mm. 22.

Chrome iron flag pole for indoor base, several lengths, divided in multiple sections, diam. mm. 22, with screw installation.



Art. 37BO Asta in Ferro Ottonato Satinato - Brass Iron Flag Pole

Asta per bandiera in ferro ottonato satinato per basi da interno in acciaio inox lucido oro, in diverse altezze, divisa in sezioni con montaggio per avvitamento, diam. mm. 22.

Brass iron flag pole for indoor base, several lengths, divided in multiple sections, diam. mm. 22, with screw installation.



Art. 37BS Asta in Alluminio Satinato -Satin Finished Aluminium Flag Pole

Asta per bandiera in alluminio satinato per basi da interno, in diverse altezze, divisa in sezioni con montaggio per avvitamento, diam. mm. 22.

Satin finished aluminium flagpole for indoor base, several lengths, divided in multiple sections, diam. mm. 22, with screw installation.

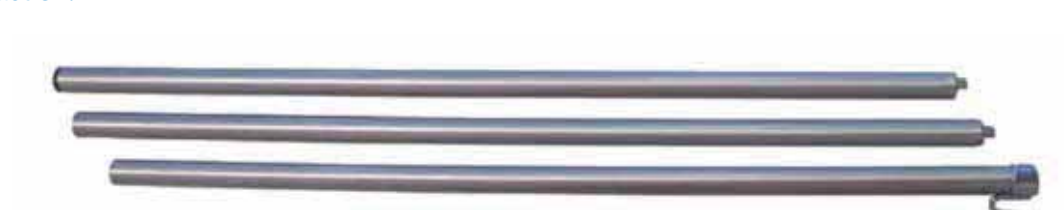

Art. 39BA01 Base in Alluminio Satinato -Mat Aluminium Satin Base

Base da interno per ufficio in alluminio satinato opaco, diam. cm. 28, completa di zavorra interna e innesto per asta, diam. mm. 22, per bandiera.

Mat aluminium satin indoor base diam. cm. 28, for pole diam. mm. 22.



Art. 39B01 Base in ottone - Brass Base

Base da interno per ufficio in ottone sia cromato che lucido, diam. cm. 30, ad un innesto per asta da mm. 22 ed anima pesante interna.

Chrome or shiny brass base for indoor diam. cm. 30, one pole, diam. mm. 22 with internal weight.



Art. 39B Base in Ottone Cromato - Chrome Plated Brass Base

Base da interno per ufficio in ottone cromato con innesti, diam. cm. 30, per aste da mm. 22, per bandiera, completa di anima pesante interna. Disponibile per sostegno a più innesti.

Chrome plated brass base for two or three poles, diam. cm. 30, for poles mm. 22 with internal weight.



Art. 39BF01 Base in Acciaio Cromato -Chrome Steel Base

Base da interno per ufficio in acciaio cromato, diam. cm. 28, a uno, due o tre innesti per asta da mm. 22 per bandiera o gonfalone, con anima pesante.

Chrome steel base, diam. cm. 30, for one, two or three poles, mm. 22 with internal weight.



Art. 42B Puntali per Aste - Flag Poles Ferrules

Puntali in ottone lucido con fregi assortiti di vari soggetti per aste da ufficio.

Brass ferrules for office flag pole.



Puntale comunale
Municipal ferrule

Art. 79B Traversino - Crossbar

Traversino in ottone cromato, diam. mm. 22, per gonfaloni, completo di pomoli laterali in ottone lucido. Disponibili diverse lunghezze.

Crossbar chrome plated for banners, diam. mm. 22. Different lengths available.



Art. 49B Asta in Velluto - Velvet Pole

Asta per gonfalone ricoperta in velluto, mono o bicolore, con borchie cromate, divisa in più parti, montaggio per avvitamento. Altezze disponibili su richiesta.

Velvet dressed poles for banners, mono or bi colored, divided in parts. Heights available on request.



Art. 35B14 Asta in Alluminio con Braccio Rotante - Aluminium Pole with Rotating Arm

Asta in alluminio per esterno, diam. mm. 35, completa di terminale e braccio rotante lunghezza massima 100 cm per bandiera formato verticale. Disponibile in diverse altezze: mt.2, mt. 3, mt.4. Verga unica.

Aluminium pole for outdoor, diam. mm. 35, with rotating arm max. length cm. 100 and ferrule for vertical flag. Available dimensions: mt. 2, mt. 3, mt.4.

Art. 35B11 Asta in Alluminio con Carrucola - Aluminium Pole with Pulley

Asta in alluminio per esterno, diam. mm. 35, completa di puntale a formagetta nero in PVC con carrucola, bitta e fune per fissaggio bandiera. Disponibile in diverse altezze mt. 2, mt. 3, mt. 4. Verga unica.

Aluminium pole, diam. mm. 35, with ferrule, pulley and cleat for rope. Available dimensions: mt.2, mt.3, mt. 4.



Art. 40B01 Attacco murale inclinato - Inclined wall attachment

Attacco murale inclinato in ferro zincato a caldo, diam. mm. 38, ad 1 innesto per asta in alluminio da diam. mm. 35 (art. 35b).

Inclined hot galvanized iron wall attachment, diam. mm. 38 for one aluminium pole diam. mm 35.

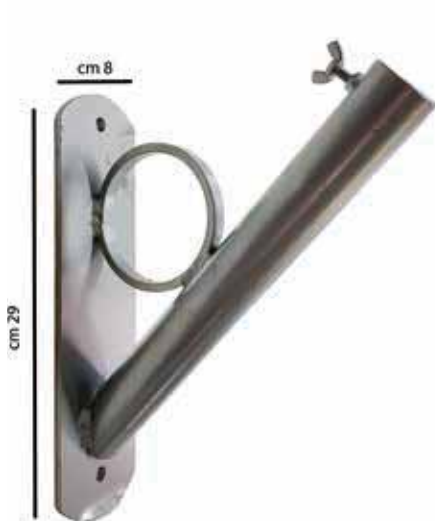

Art. 40B02 Attacco murale verticale - Vertical wall attachment

Attacco murale verticale in ferro zincato a caldo per esterno, diam. mm. 38, ad 1 innesto per asta da diam. 35 mm (art. 35b).

Vertical hot galvanized iron wall attachment, diam. mm. 38, for one aluminium pole diam. mm. 35.



Art. 40B03 Attacco Murale Inclinato - Inclined wall attachment

Attacco murale inclinato in ferro zincato a caldo per esterno, a due posti, diam. mm. 38 per asta in alluminio da diam. mm. 35 (art. 35b).

Inclined hot galvanized iron wall attachment, for 2 poles, diam. mm. 38 for aluminium poles diam. mm. 35.

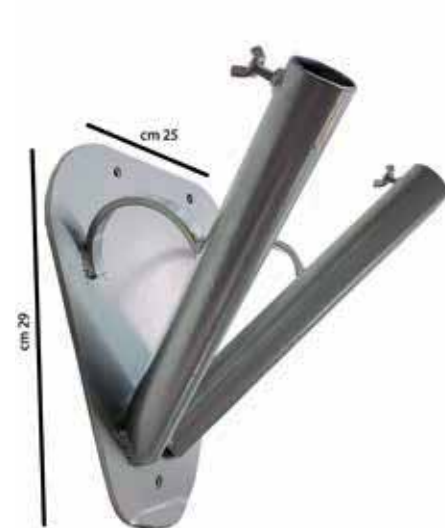

Art. 40B04 Attacco murale a raggera - Wall attachment

Attacco murale a raggera in ferro zincato a caldo per esterno, a tre posti, diam. mm. 38, per asta in alluminio da diam. mm. 35 (art. 35b).

Hot galvanized iron wall attachment, diam. mm. 38, for 3 aluminium poles diam. mm. 35 (art. 35b).

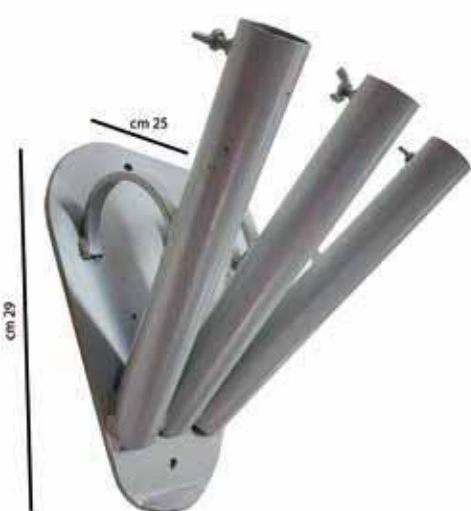

Art. 40B05 Piastre in ferro zincato - Iron soleplate set

Set composto da due piastre in ferro zincato a caldo per esterno per montaggio pennone in alluminio (art. 34b).

Hot galvanized iron soleplate set for aluminium mast (art. 34b).



Art. 40B06 Attacco murale inclinato per pennoni- Inclined wall attachment for masts

Attacco murale inclinato per parete in ferro zincato a caldo per esterno, diam. mm. 50 per pennone in alluminio.

Inclined hot galvanized iron wall attachment, diam. mm. 50, for aluminium mast.



Art. 38B Basi Portabandiera - Flag Pole Bases

Basi portabandiera a più innesti in ferro zincato a caldo per esterno, forma quadrata con lato cm. 30 o 35, (da 1 a 5 innesti), per asta in alluminio diam. mm. 35 (art. 35b).

Hot galvanized iron base for outdoor use, square shape size cm. 30 or 35 (from one to five poles) for aluminium flag poles diam. mm. 35 (art. 35b)



Art. 38B08 Piantana sottoruota per aste in alluminio - Under wheel base for aluminium poles

Piantana sottoruota in ferro zincato per aste in alluminio (art. 35b).

Under wheel base in galvanized iron for aluminium pole (art. 35b).



Art. 01A01 Terminale - Ferrule

Terminale in nylon, diam. mm. 30 per asta di alluminio (art. 35b).

Nylon ferrule, diam. mm. 30, for aluminium pole (art. 35b).



Art. 01A02 Gancio - Hook

Gancio in nylon per aggancio bandiera su asta in alluminio (art. 35b).

Nylon hook, for hanging the flag on the aluminium pole (art. 35b).



Art. 01A03 Passafune - Cleat

Passafune in nylon per blocco sagola bandiera su asta in alluminio (art. 35b).

Nylon cleat for flag line block on pole (art. 35b).



Art. 01A04 Bitta - Cleat

Bitta in nylon per blocco sagola bandiera su asta in alluminio, diam. mm. 35 (art. 35b).

Nylon cleat for flag line block on pole, diam. mm. 35 (art. 35b).



Art. 34T Pennone Telescopico - Telescopic Mast

Pennone telescopico in alluminio anodizzato con braccio rotante cm. max. 110, disponibile in due altezze h. mt. 4,00 o 5,50 con base auto portante o sotto ruota, completo di accessori per bandiera.

Telescopic aluminium mast, with rotating arm, cm. max. 110, available on two heights mt. 4,00 or 5,50, with self supporting or under wheel base and flag accessories.



Art. 38T02 Base Sottoruota - Under Wheel Base

Base sottoruota in ferro verniciato per pennone telescopico (art. 34T).

Under wheel silver painted steel base to use with telescopic mast (Art. 34T).



Art. 38BT01 Base in Ferro Zincato - Hot Galvanized Steel Base

Base in ferro zincato a caldo, auto portante, a forma quadrata lato cm. 60, per pennone telescopico (Art. 34T), peso 23 kg.

Hot galvanized self-supporting steel base to use with telescopic mast (Art. 34T), square shape size cm. 60, weight 23 kg.

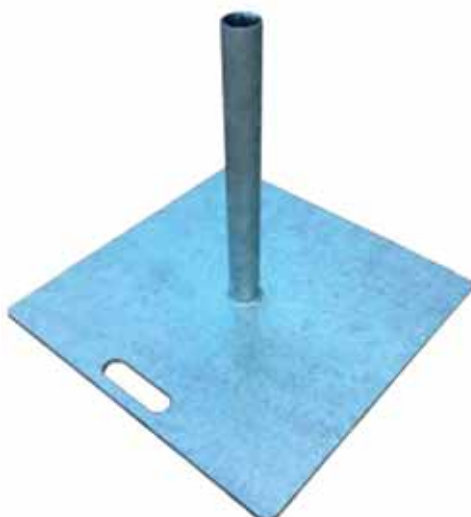

Art. 34T03 Pennone Telescopico - Telescopic Mast

Pennone telescopico in alluminio completo di braccio rotante e base in PVC riempibile di acqua. Disponibile in due altezze: mt. 5,50 e 7 con borsa per il trasporto.

Telescopic aluminium mast, with rotating arm and water PVC base. Available in two heights: mt. 5,50 or 7 and a carry bag.



Art. 34AFE Pennone in alluminio - Aluminium Mast

Pennone modello classico, rastremato in alluminio anodizzato per esterno colore argento, completo di carrucola, bitta e fune. Installazione tramite plinto di cemento di almeno il 10% dell'altezza. Misure e caratteristiche nelle tabelle sottostanti.

Aluminium mast with external halyard, with pulley, belying cleat and rope. Installation with concrete slab for at least 10% of the height. Dimensions and main features in the tables below.



Articoli in dotazione - Items Supplied

Fune in poliestere o polipropilene - polyester or polypropylene rope

Bitta - Belying cleat

Carrucola - Pulley

Articoli opzionali - Optional Articles

Art: 01A07



Art: 01A10



Art: 01A12



Art: 01A18



Descrizioni tecniche e immagini degli accessori a pag. 73

Technical descriptions and items images at page 73

| | Art. 34AFE01 | Art. 34AFE02 | Art. 34AFE03 | Art. 34AFE04 | Art. 34AFE05 | Art. 34AFE06 | Art. 34AFE07 |
|--|--------------|--------------|--------------|--------------|--------------|--------------|--------------|
| Altezza Height | 5 | 6 | 7 | 8 | 9 | 10 | 12 |
| Numero di sezioni Number of section (pCS) | 2 | 2 | 3 | 3 | 4 | 4 | 4 |
| Diametro (superiore/inferiore) Flagpole diameter (top/bottom) (mm) | 50/60 | 60/70 | 60/70/80 | 70/80/90 | 70/80/90/100 | 70/80/90/100 | 70/80/90/100 |
| Peso netto senza accessori Net weight without accessories (kg) | 10 | 12 | 14 | 16 | 18 | 20 | 22 |
| Dimensione Massima consigliata della bandiera Recommended size of the flag (Mt) | 100x150 | 100x150 | 130x200 | 150x225 | 150x225 | 200x300 | 250x375 |
| Dimensione imballaggio senza base ribaltabile Size of package without hinged base | 335x8x8 | 335x8x8 | 350x10x10 | 360x11x11 | 380x12x12 | 380x12x12 | 380x12x12 |



Art. 34ABR Pennone con Braccio Rotante - Rotating Arm Mast

Pennone rastremato in alluminio anodizzato per esterno colore argento, completo di sistema rotante composto da braccio lungo cm. 150 max., terminale dorato/argentato, fascette in plastica con chiusura a pressione per fissaggio bandiera sul lato verticale, peso tendibandiera in acciaio max gr. 800 e base ribaltabile in ferro zincato a caldo con tirafondi da installare tramite plinto di cemento. Misure e caratteristiche nelle tabelle sottostanti.

Telescopic anodized silver aluminium mast for outdoor, with max. 150 cm. rotating arm, gold/silver-plated finial, plastic pressure rings, flag weight max. gr. 800 and hot galvanized steel hinged base plate. Dimensions and main features in the tables below.

Articoli in dotazione - Items Supplied

Art: 01A07



Art: 01A09



Art: 01A11



Art: 01A18



Descrizioni tecniche e immagini degli accessori a pag. 73

Technical descriptions and items images at page 73

| | Art. 34ABR01 | Art. 34ABR02 | Art. 34ABR03 | Art. 34ABR04 | Art. 34ABR05 | Art. 34ABR06 | Art. 34ABR07 |
|--|----------------------|----------------------|------------------------|------------------------|------------------------|------------------------|------------------------|
| Altezza Height | 5 | 6 | 7 | 8 | 9 | 10 | 12 |
| Numero di sezioni Number of section (pCS) | 2 | 2 | 3 | 3 | 4 | 4 | 4 |
| Diametro (superiore/inferiore) Flagpole diameter (top/bottom) (mm) | 50/60 | 60/70 | 60/70/80 | 70/80/90 | 70/80/90/100 | 70/80/90/100 | 70/80/90/100 |
| Peso netto senza accessori Net weight without accessories (kg) | 10 | 12 | 14 | 16 | 18 | 20 | 22 |
| Dimensione Massima consigliata della bandiera Recommended size of the flag (Mt) | 100x300 | 100x400 | 120x450 | 130x500 | 150x550 | 150x600 | 150x650 |
| Dimensione imballaggio senza base ribaltabile Size of package with hinged base | 335x8x8 430x23x20 | 335x8x8 450x23x20 | 350x10x10 490x23x20 | 360x11x11 530x23x20 | 380x12x12 570x23x20 | 380x12x12 610x23x20 | 380x12x12 650x23x20 |

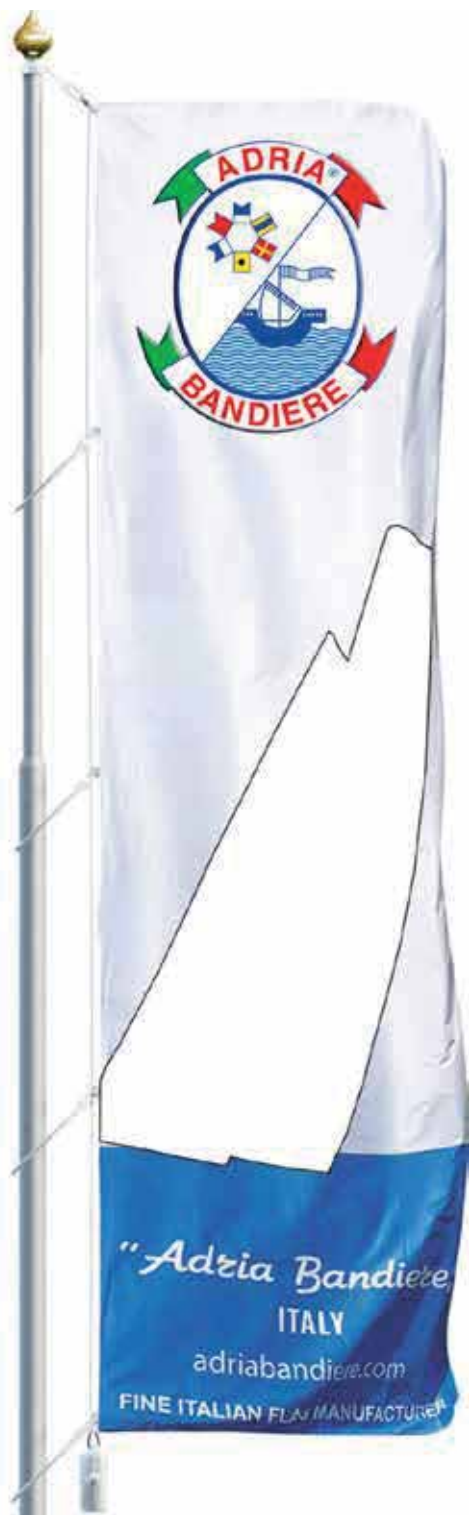

Art. 34AFI Pennone con Fune Interna - Internal Halyard Mast

Pennone rastremato in alluminio anodizzato per esterno colore argento, a fune interna con terminale dorato/argentato, fascette in plastica con chiusura a pressione per fissaggio bandiera sul lato verticale e peso tendibandiera mx. 800 gr. Installazione nel terreno tramite plinto di cemento di almeno il 10% dell'altezza. Misure e caratteristiche nelle tabelle sottostanti.

Telescopic anodized silver aluminium mast, with internal rotating halyard system, gold/silver plated finial, plastic rings and flag weight. Installation with concrete slab for at least 10% of the height. Dimensions and main features in the tables below.

Articoli in dotazione - Supplied Items

Fune in poliestere + moschettone rotante + sfera di fine corsa
Rope + swivel + distance ball
Strozza scotte interno - Internal deat lop
Verricello interno - Hoisting winch

Art: 01A07



Art: 01A11



Art: 01A25



Articoli opzionali - Optional Articles

Art: 01A10



Art: 01A18



Descrizioni tecniche e immagini degli accessori a pag. 73

Technical descriptions and items images at page 73

| | Art. 34AFI01 | Art. 34AFI02 | Art. 34AFI03 | Art. 34AFI04 | Art. 34AFI05 | Art. 34AFI06 | Art. 34AFI07 |
|--|----------------------|----------------------|------------------------|------------------------|------------------------|------------------------|------------------------|
| Altezza Height | 5 | 6 | 7 | 8 | 9 | 10 | 12 |
| Numero di sezioni Number of section (pCS) | 2 | 2 | 3 | 3 | 4 | 4 | 4 |
| Diametro (superiore/inferiore) Flagpole diameter (top/bottom) (mm) | 50/60 | 60/70 | 60/70/80 | 70/80/90 | 70/80/90/100 | 70/80/90/100 | 70/80/90/100 |
| Peso netto senza accessori Net weight without accessories (kg) | 10 | 12 | 14 | 16 | 18 | 20 | 22 |
| Dimensione Massima consigliata della bandiera Recommended size of the flag (Mt) | 100x300 | 100x400 | 120x450 | 130x500 | 150x550 | 150x600 | 150x650 |
| Dimensione imballaggio senza base ribaltabile Size of package with hinged base | 335x8x8 430x23x20 | 335x8x8 450x23x20 | 350x10x10 490x23x20 | 360x11x11 530x23x20 | 380x12x12 570x23x20 | 380x12x12 610x23x20 | 380x12x12 650x23x20 |

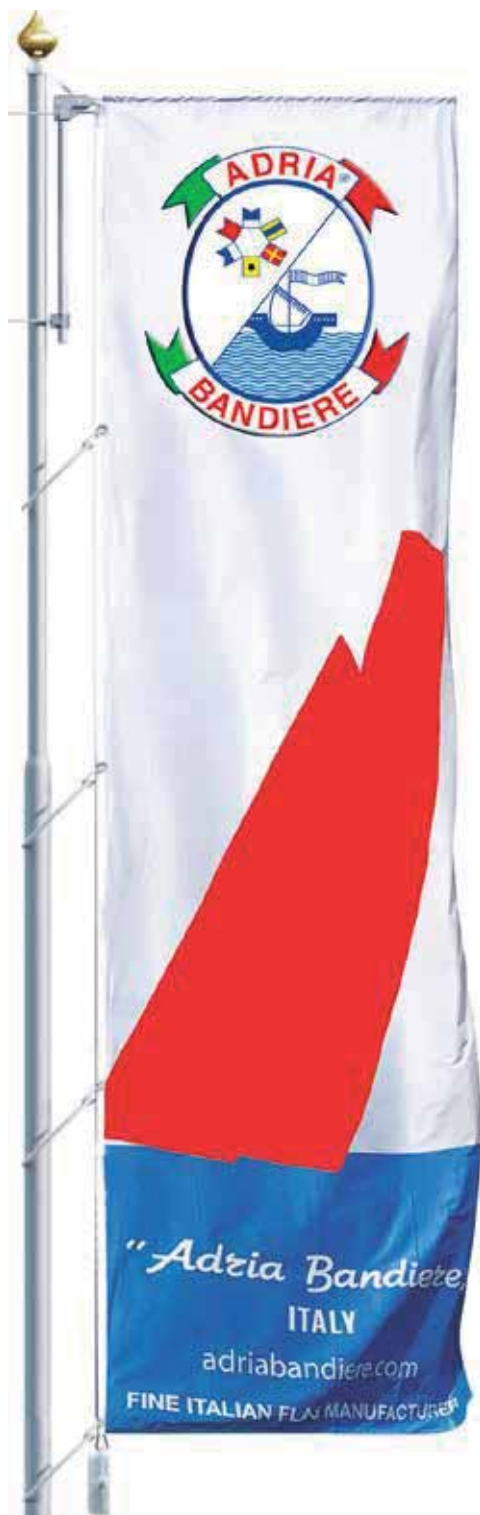

Art. 34AFI WIND TRACK Pennone in Alluminio con Fune interna e Wind Track - Aluminium Mast with Internal Halyard and Wind Track

Pennone modello classico con fune interna, rastremato in alluminio anodizzato per esterno colore argento, completo di wind track. Installazione tramite plinto di cemento di almeno il 10% dell'altezza. Misure e caratteristiche nelle tabelle sottostanti.

Aluminium mast with internal halyard, with wind track. Installation with concrete slab for at least 10% of the height. Dimensions and main features in the tables below.

Articoli in dotazione - Supplied Items

Fune in poliestere + moschettone rotante + sfera di fine corsa
 Rope + swivel + distance ball
 Strozza scotte interno - Internal deat lop
 Verricello interno - Hoisting winch

Art: 01A10



Art: 01A11



Art: 01A25



Articoli opzionali - Optional Articles

Art: 01A07



Art: 01A18



Descrizioni tecniche e immagini degli accessori a pag. 73
Technical descriptions and items images at page 73

| | Art. 34AFI01 | Art. 34AFI02 | Art. 34AFI03 | Art. 34AFI04 | Art. 34AFI05 | Art. 34AFI06 | Art. 34AFI07 |
|--|----------------------|----------------------|------------------------|------------------------|------------------------|------------------------|------------------------|
| Altezza Height | 5 | 6 | 7 | 8 | 9 | 10 | 12 |
| Numero di sezioni Number of section (PCS) | 2 | 2 | 3 | 3 | 4 | 4 | 4 |
| Diametro (superiore/inferiore) Flagpole diameter (top/bottom) (mm) | 50/60 | 60/70 | 60/70/80 | 70/80/90 | 70/80/90/100 | 70/80/90/100 | 70/80/90/100 |
| Peso netto senza accessori Net weight without accessories (kg) | 10 | 12 | 14 | 16 | 18 | 20 | 22 |
| Dimensione Massima consigliata della bandiera Recommended size of the flag (Mt) | 100x300 | 100x400 | 120x450 | 130x500 | 150x550 | 150x600 | 150x650 |
| Dimensione imballaggio senza base ribaltabile Size of package with hinged base | 335x8x8 430x23x20 | 335x8x8 450x23x20 | 350x10x10 490x23x20 | 360x11x11 530x23x20 | 380x12x12 570x23x20 | 380x12x12 610x23x20 | 380x12x12 650x23x20 |



Art. 34VFE Pennone in vetroresina con fune esterna - Fiberglass Mast with External Halyard

Pennone modello classico in vetroresina, verga unica con forma conica, fune esterna, finitura smalto bianco lucido, completo di bulbo terminale dorato o argentato, sagola, bitta e base incernierata.

Misure e caratteristiche nelle tabelle sottostanti.

Conical fiberglass mast, white colour, complete with external halyard, belying cleat and hinged base with tie roots. Dimensions and features in the tables below.

Articoli in dotazione - Supplied Items

Fune in poliestere o polipropilene - polyester or polypropylene rope

Bitta - Belying cleat

Carrucola - Pulley

Art: 01A12



Art: 01A18



Articoli opzionali - Optional Articles

Art: 01A07



Art: 01A10



Descrizioni tecniche e immagini degli accessori a pag. 73

Technical descriptions and items images at page 73

| | Art. 34VFE01 | Art. 34VFE02 | Art. 34VFE03 | Art. 34VFE04 | Art. 34VFE05 | Art. 34VFE06 | Art. 34VFE08 |
|--|--------------|--------------|--------------|--------------|--------------|--------------|--------------|
| Altezza Height | 5 | 6 | 7 | 8 | 9 | 10 | 12 |
| Numero di sezioni Number of section (pCS) | 1 | 1 | 1 | 1 | 1 | 1 | 1 |
| Diametro (superiore/inferiore) Flagpole diameter (top/bottom) (mm) | 65/115 | 65/115 | 65/115 | 65/115 | 65/115 | 65/135 | 65/135 |
| Peso netto senza accessori Net weight without accessories (kg) | 23 | 25 | 26 | 28 | 30 | 41 | 44 |
| Dimensione Massima consigliata della bandiera Recommended size of the flag (Mt) | 100x150 | 100x150 | 130x200 | 150x225 | 150x225 | 200x300 | 250x375 |
| Dimensione imballaggio senza base ribaltabile Size of package without hinged base | 520x15x15 | 620x15x15 | 720x15x15 | 820x15x15 | 920x18x18 | 1020x18x18 | 1220x18x18 |



Art. 34VBR Pennone in Vetroresina con Braccio Rotante Fiberglass Rotating Arm Mast

Pennone in vetroresina, verga unica, forma conica, con finitura smalto bianco lucido, completo di sistema rotante composto da braccio in alluminio lungo cm. 150 max., terminale dorato/argentato, fascette in plastica con chiusura a pressione per fissaggio bandiera sul lato verticale, peso tendibandiera in acciaio max. 800 gr., base incernierata con tiranti da installare tramite plinto di cemento. Misure e caratteristiche nella tabella sottostante.

Fiberglass conical mast for outdoor use, white color, with rotating arm max. length cm. 150, gold/silver ferrule, plastic ties for flag fixing on vertical side, steel tensioner weight max. gr. 800, hinged base with tie rods. Installation by concrete slab. Measures and main features in the tables below.

Articoli in dotazione - Supplied Items

Art: 01A07



Art: 01A09



Art: 01A11



Art: 01A18



Descrizioni tecniche e immagini degli accessori a pag. 73
Technical descriptions and items images at page 73

| | Art. 34VBR01 | Art. 34VBR02 | Art. 34VBR03 | Art. 34VBR04 | Art. 34VBR05 | Art. 34VBR06 | Art. 34VBR08 |
|--|--------------|--------------|--------------|--------------|--------------|--------------|--------------|
| Altezza Height | 5 | 6 | 7 | 8 | 9 | 10 | 12 |
| Numero di sezioni Number of section (pCS) | 1 | 1 | 1 | 1 | 1 | 1 | 1 |
| Diametro (superiore/inferiore) Flagpole diameter (top/bottom) (mm) | 65/115 | 65/115 | 65/115 | 65/115 | 65/115 | 65/135 | 65/135 |
| Peso netto senza accessori Net weight without accessories (kg) | 24 | 26 | 28 | 29 | 31 | 42 | 46 |
| Dimensione Massima consigliata della bandiera Recommended size of the flag (Mt) | 100x300 | 100x400 | 120x450 | 130x500 | 150x550 | 150x600 | 150x650 |
| Dimensione imballaggio senza base ribaltabile Size of package without hinged base | 520x15x15 | 620x15x15 | 720x15x15 | 820x15x15 | 920x18x18 | 1020x18x18 | 1220x18x18 |

Art. 34VFI Pennone in Vetroresina con Fune Interna - Fiberglass Mast with Internal Halyard

Pennone in vetroresina, verga unica, forma conica, con finitura smalto bianco lucido, completo di sistema rotante, terminale dorato/argentato, fascette in plastica con chiusura a pressione per fissaggio bandiera sul lato verticale, peso tendibandiera in acciaio max. 800 gr., base incernierata con tiranti. da installare tramite plinto di cemento. Misure e caratteristiche nella tabella sottostante.

Fiberglass conical mast for outdoor use, white color, gold/silver ferrule, plastic ties for flag fixing on vertical side, steel tensioner weight max. gr. 800, hinged base with tie rods. Installation by concrete slab. Measures and main features in the tables below.

Articoli in dotazione - Supplied Items

Art: 01A07



Art: 01A11



Art: 01A18



Art: 01A25



Descrizioni tecniche e immagini degli accessori a pag. 73
Technical descriptions and items images at page 73

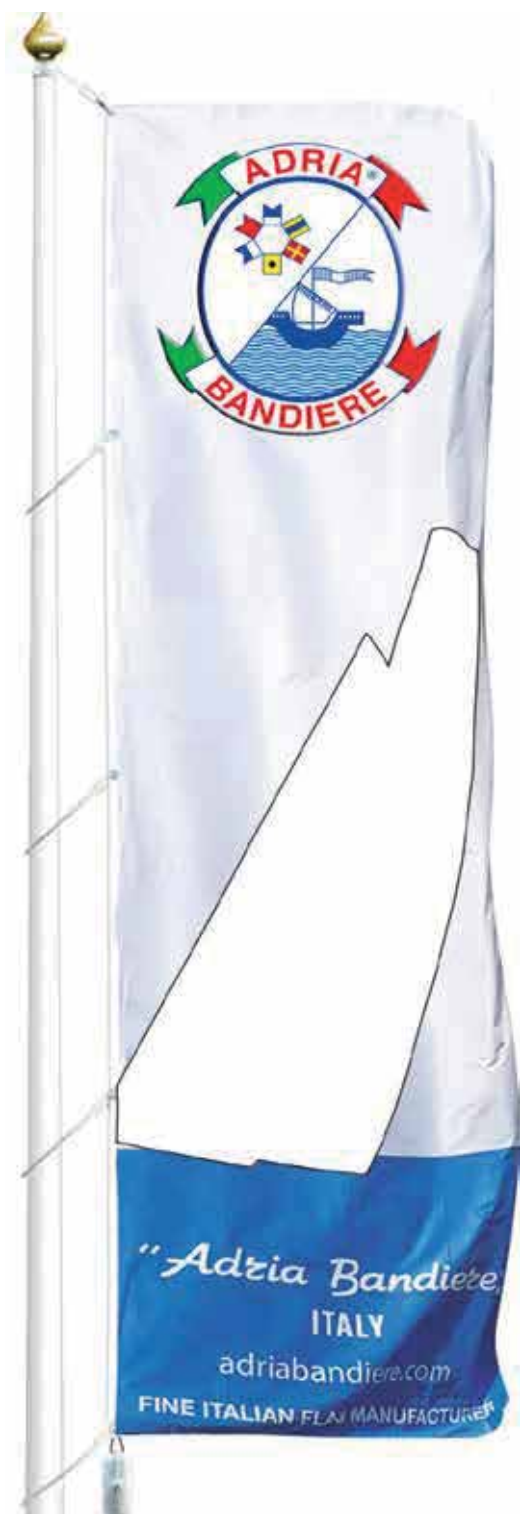

| | Art. 34VFI01 | Art. 34VFI02 | Art. 34VFI03 | Art. 34VFI04 | Art. 34VFI05 | Art. 34VFI06 | Art. 34VFI08 |
|--|--------------|--------------|--------------|--------------|--------------|--------------|--------------|
| Altezza Height | 5 | 6 | 7 | 8 | 9 | 10 | 12 |
| Numero di sezioni Number of section (pCS) | 1 | 1 | 1 | 1 | 1 | 1 | 1 |
| Diametro (superiore/inferiore) Flagpole diameter (top/bottom) (mm) | 65/115 | 65/115 | 65/115 | 65/115 | 65/115 | 65/135 | 65/135 |
| Peso netto senza accessori Net weight without accessories (kg) | 23 | 25 | 26 | 28 | 30 | 41 | 44 |
| Dimensione Massima consigliata della bandiera Recommended size of the flag (Mt) | 100x300 | 100x400 | 120x450 | 130x500 | 150x550 | 150x600 | 150x650 |
| Dimensione imballaggio senza base ribaltabile Size of package without hinged base | 520x15x15 | 620x15x15 | 720x15x15 | 820x15x15 | 920x18x18 | 1020x18x18 | 1220x18x18 |

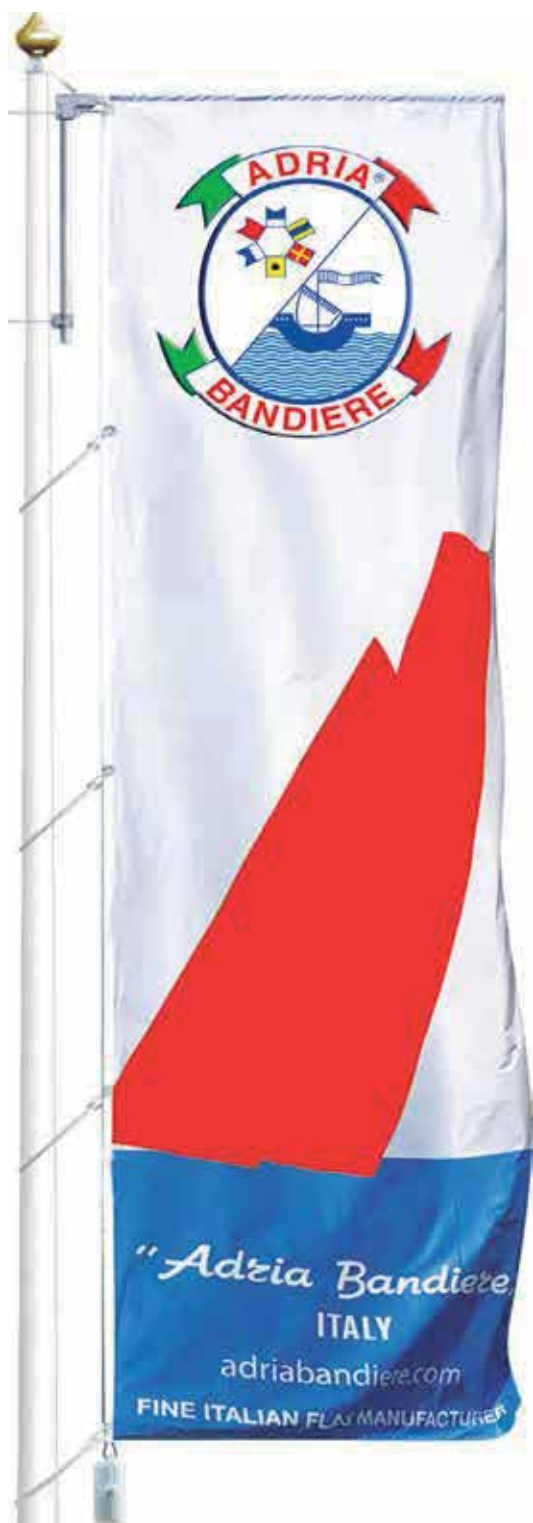

Art. 34VFI WIND TRACK Pennone in Vetroresina con Fune Interna e Wind Truck - **Fiberglass Mast with Internal Halyard and Wind Track**

Pennone in vetroresina, verga unica, forma conica, con finitura smalto bianco lucido, fune interna, completo di sistema wind track e base incernierata. Misure e caratteristiche nelle tabelle sottostanti.

Fiberglass mast with internal halyard, wind track and hinged base. Dimensions and main features in the tables below.

Articoli in dotazione - **Supplied Items**

Art: 01A07



Art: 01A10



Art: 01A11



Art: 01A25



Descrizioni tecniche e immagini degli accessori a pag. 73
Technical descriptions and items images at page 73

| | Art. 34VRFI02 | | | Art. 34VRFI04 | | | Art. 34VRFI06 | |
|--|---------------|-----------|-----------|---------------|-----------|------------|---------------|--|
| Altezza Height | 5 | 6 | 7 | 8 | 9 | 10 | 12 | |
| Numero di sezioni Number of section (pCS) | 1 | 1 | 1 | 1 | 1 | 1 | 1 | |
| Diametro (superiore/inferiore) Flagpole diameter (top/bottom) (mm) | 65/115 | 65/115 | 65/115 | 65/115 | 65/115 | 65/135 | 65/135 | |
| Peso netto senza accessori Net weight without accessories (kg) | 24 | 26 | 28 | 29 | 31 | 42 | 46 | |
| Dimensione Massima consigliata della bandiera Recommended size of the flag (Mt) | 100x300 | 100x400 | 120x450 | 130x500 | 150x550 | 150x600 | 150x650 | |
| Dimensione imballaggio senza base ribaltabile Size of package without hinged base | 520x15x15 | 620x15x15 | 720x15x15 | 820x15x15 | 920x18x18 | 1020x18x18 | 1220x18x18 | |

Accessori Pennoni - Flagpole Accessories



01A12 Terminale - Finials

Puntale in metallo a forma di bulbo color oro o argento diam. mm. 135.

Golden or silver bulb round finial 135 mm.



01A07FO Peso Drop in ferro ricoperto in plastica bianca gr. 800- **Iron weight covered with white plastic**



01A25 Sistema rotante con terminale a forma di bulbo **Rotating system with silver**



01A07 Peso tendi-bandiera in metallo ricoperto di plastica bianca con anello a giro gr. 1300 - **Metal weight covered with white plastic gr. 1300**



01A09 Sistema braccio rotante - **Rotating arm with silver terminal and 3 plastic rings**



01A07CO Peso a collare cobra in plastica bianca gr. 1100- **Weight in white plastic gr. 1100**



01A11 Anelli in Plastica - **Plastic Rings**



01A07 Peso tendi-bandiera gr. 250-450-800 - **Flag Weight gr. 250-450-800**



01A10 Braccio Saliscendi **Windtracker - Windtracker Arm**



Fune in poliestere o polipropilene - **Rope (polyester or polypropylene)**



01A18 Base ribaltabile in ferro zincato a caldo completa di tiranti e dadi. **Hinged base plate 65/80/82,5/95 mm**



Strozza scotte interno - **internal deat lop**



Verricello interno - **Hoisting winch**

Le nostre bandiere sono normalmente confezionate in maniera classica per asta o per pennone ma, su indicazione del cliente, possono essere confezionate in maniera differente per le diverse situazioni.

Our flags are usually made in a standard way for poles but, on request, they can be sewn in a different way for every kind of situations.



La confezione classica prevede un orlo perimetrale con doppia cucitura, guaina bianca di rinforzo e sagola per affissione all'asta.

Standard sewn is with double hem, sheath and rope.



Confezione con nocciola - *Sewn with toggle*



La confezione per bandiera verticale, per struttura con braccio, prevede un'asola in alto chiusa al battente e moschettoni in PVC bianco o anelli a D e triangolo in basso per peso tendi bandiera.

Sewn for vertical shape flags is with a loop on the top or white PVC eyelets or D rings and triangular tending weight.



Confezione con triangolo in PVC bianco per aggancio peso tendi bandiera.

Sewn with white PVC triangle for tending weight flag.



Confezione con doppio gancio - *Sewn with double hook*



Confezione con asola in alto per struttura con braccio e fascette di guaina cucite sul lato dell'asta.

Sewn with a loop on the top and embroidered sheath depthwrappers for arm pole.



Confezione con asola in alto per struttura con braccio e moschettoni in PVC bianco lato asta.

Sewn with a loop on the top and white PVC snap-hooks for arm pole.



Confezione per bandiera keder.

Sewn for keder flags.

Note

A series of 28 horizontal dotted lines for writing notes.



THE INTERNATIONAL CERTIFICATION NETWORK

CERTIFICATE

CISQ /RINA has issued an IQNet recognized certificate that the organization:

ADRIA BANDIERE S.R.L.

VIA ARNO 23 47042 Cesenatico (FC) ITALIA

in the following operative units:

VIA ARNO 23 47042 Cesenatico (FC) ITALIA

has implemented and maintains a
Quality Management System
for the following scope:

DESIGN, DEVELOPMENT AND PRODUCTION OF NATIONAL, FOREIGN AND PERSONALISED FLAGS, PENNANTS, LABARUMS, POLES, MASTS, PENNANTS AND ACCESSORIES FOR FLAGS AND NAUTICAL EMBROIDERED LINEN MADE IN ITALY

which fulfills the requirements of the following standard:

ISO 9001:2015

Issued on: 2021-06-07

First Issued on: 2000-12-28

Expires on: 2024-06-25

This attestation is directly linked to the IQNet Partner's original certificate and shall not be used as a stand-alone document

CISQ/RINA original certificate no.: 4296/00/S

Registration Number: IT-16784



Alex Stoichitoiu
President of IQNET



Ing. Mario Romersi
President of CISQ

IQNet Partners*:

AENOR Spain AFNOR Certification France APCER Portugal CCC Cyprus CISQ Italy
CQC China CQM China CQS Czech Republic Cro Cert Croatia DQS Holding GmbH Germany EAGLE Certification Group USA
FCAV Brazil FONDONORMA Venezuela ICONTEC Colombia Inspecta Serfifointi Oy Finland INTECO Costa Rica
IRAM Argentina IQA Japan KFQ Korea MIRTEC Greece MSZT Hungary Nemko AS Norway NSAI Ireland
NYCE-SIGE Mexico PCBC Poland Quality Austria Austria RR Russia SII Israel SIQ Slovenia
SIRIM QAS International Malaysia SQS Switzerland SRAC Romania TEST St Petersburg Russia TSE Turkey YUQS Serbia

* The list of IQNet partners is valid at the time of issue of this certificate. Updated information is available under www.iqnet-certification.com



IQNet, the association of the world's first class certification bodies, is the largest provider of management System Certification in the world. IQNet is composed of more than 30 bodies and counts over 150 subsidiaries all over the globe.

CERTIFICATO N. 4296/00/S CERTIFICATE No.

SI CERTIFICA CHE IL SISTEMA DI GESTIONE PER LA QUALITÀ DI
IT IS HEREBY CERTIFIED THAT THE QUALITY MANAGEMENT SYSTEM OF

ADRIA BANDIERE S.R.L.

VIA ARNO 23 47042 Cesenatico (FC) ITALIA
NELLE SEGUENTI UNITÀ OPERATIVE / IN THE FOLLOWING OPERATIONAL UNITS

VIA ARNO 23 47042 Cesenatico (FC) ITALIA

È CONFORME ALLA NORMA / IS IN COMPLIANCE WITH THE STANDARD
ISO 9001:2015

PER I SEGUENTI CAMPI DI ATTIVITÀ / FOR THE FOLLOWING FIELD(S) OF ACTIVITIES

PROGETTAZIONE, SVILUPPO E PRODUZIONE IN ITALIA DI BANDIERE NAZIONALI, ESTERE E PERSONALIZZATE, GAGLIARDETTI, LABARI, GONFALONI, ASTE, PENNONI ED ACCESSORI PER BANDIERE E DI BIANCHERIA RICAMATA PER LA NAUTICA

IAF:04

DESIGN, DEVELOPMENT AND PRODUCTION OF NATIONAL, FOREIGN AND PERSONALISED FLAGS, PENNANTS, LABARUMS, POLES, MASTS, PENNANTS AND ACCESSORIES FOR FLAGS AND NAUTICAL EMBROIDERED LINEN MADE IN ITALY

La validità del presente certificato è subordinata a sorveglianza periodica annuale / semestrale ed al riesame completo del sistema di gestione con periodicità triennale

The validity of this certificate is dependent on an annual / six monthly audit and on a complete review, every three years, of the management system

L'uso e la validità del presente certificato sono soggetti al rispetto del documento RINA: Regolamento per la Certificazione di Sistemi di Gestione per la Qualità

The use and validity of this certificate are subject to compliance with the RINA document : Rules for the certification of Quality Management Systems

| | | | |
|--------------------------------|-------------------|--|-------------------|
| Prima emissione First Issue | <u>28.12.2000</u> | Data decisione di rinnovo Renewal decision date | <u>07.06.2021</u> |
| Data scadenza Expiry Date | <u>25.06.2024</u> | Data revisione Revision date | <u>07.06.2021</u> |

Rocco Amendola

Bologna Management System
Certification, Head

RINA Services S.p.A.
Via Corsica 12 - 16128 Genova Italy



www.cisq.com



SGQ N° 002 A

Membro degli Accordi di Mutuo Riconoscimento EA, IAF e ILAC
Signatory of EA, IAF and ILAC Mutual Recognition Agreements

CISQ è la Federazione Italiana di Organismi di Certificazione dei sistemi di gestione aziendale
CISQ is the Italian Federation of management system Certification Bodies



Viale Arno 23 · 47042 Cesenatico (FC) · ITALY
Tel: +39 0547 672090 · 672314 · 673299 Fax: +39 0547 672048
www.adriabandiere.com · commerciale@adriabandiere.com